



MicroPlayer mkIII



Audio player MP3/Wav

USER MANUAL

Table of contents

A - Safety instructions	1
B - Product information	3
1 - Product presentation	4
2 - Functionalities	4
3 - Installation	5
3.1 - Connections	7
4 - Operating mode	9
4.1 - Organisation of the folders	9
4.2 - Organisation of files inside folders	14
5 - Setup file	19
6 - RS232 serial link protocol	25
7 - From the MicroPlayer to the MicroPlayer MKII	29
8 - Firmware Update	29
Appendix A - Characteristics	30
Appendix B - Functionalities	31
Appendix C : Infrared remote control	32

ID-AL products are exclusively manufactured by Waves System

LA VILLE EN BOIS - 44830 BOUAYE - FRANCE

Sales and information: +33 2 40 78 22 44

E-mail : info@id-al.com - Web site: <http://www.id-al.com>

Technical department : support@wssystem.com

Technical support :

For a detailed list of the technical support options, we suggest you to visit our site www.id-al.com.

Information in this manual is subject to change without notice and do not represent any commitment from Waves System. The equipment described in this manual is supplied under condition of the terms of license specifying the legal use conditions. This manual can't be reproduced or used, in whole or in part, in any form and by any mean, for other use than private, without the written permission from Waves System.

ID-AL is a trademarks of Waves System.

CAUTION! DO NOT EXPOSE TO HUMIDITY & DUST!

Unplug the power supply cable before any servicing

FOR YOUR SAFETY, PLEASE READ THE USER'S GUIDE CAREFULLY BEFORE OPERATING YOUR PLAYER.

A. SAFETY INSTRUCTIONS

A.1 CE marking

The CE marking is found on the nameplate, at the rear side of the device. It certifies the conformance of the device with the low voltage CE Directive, according to the EN 55022 standard, and the Electromagnetic Compatibility Directive 61000-4-x.

A.2 Directives

- The requirements related to the electromagnetic compatibility and low voltages directive are met.

A.3 Overview

- The user manual is an integral part of the product. It must always be kept handy & close by. Proper usage conforming to the product intended purpose involves strict compliance with the instructions given in this manual.

In the event of return of the equipment, the user manual should be handed over to the new purchaser. The staff should receive instructions concerning the proper usage of the device.

- Only usage of genuine parts ensures perfect safety for the user and correct operation of the device. Moreover, only accessories mentioned in the technical documentation or explicitly approved by the manufacturer must be used. In the event of usage of accessories or consumable products from other brands, the manufacturer cannot stand guarantee for the correct and safe operation of the device.

- Damages caused through usage of accessories or consumable products from other brands will not entail right to any benefit under the terms of warranty.

- The manufacturer will be liable for the safety, reliability and functioning of the product as long as the assembly, settings, modifications, extensions and repairs have been carried out by the manufacturer or a company approved by the manufacturer and if the device is used in accordance with the instructions mentioned in this manual.

- The player complies with the technical safety standards in force at the date of print of this manual. All rights reserved for the electrical diagrams, procedures, names and devices mentioned herein.

- Any reproduction of the technical documentation, even partially, without the written authorization from Waves System is prohibited.

A.4 General Safety instructions

This device has been shipped out from our facilities in perfect working condition. In order to preserve these conditions, for safety and to avoid any risk of accidental bodily injury, the user must imperatively follow the safety instructions and read the 'Caution!' messages included in this manual.

This device, made by Waves System, has been designed in a way that practically eliminates any risk if it is used in accordance to its intended purpose. Nevertheless, with a concern for safety, we would like to draw your attention to the following instructions:

- When using the device, comply with all local rules and regulations in force. Any modification or conversion of the device automatically entails loss of the homologation. The operation of a modified device is liable to a penalty. In the interest of occupational safety, the operator and the user are held responsible for complying with the regulations.
- Keep the original packing for a possible product re-shipment. Also ensure to keep the packing material out of children's reach. Only this original packing ensures optimal protection for the product during transportation. If a product reshipment appears to be necessary during the guarantee period, Waves System is not liable for any ensuing damages arising during the transportation and attributable to a defective packing.
- This device is used to broadcast audio files. It should be used only by persons whose training or knowledge ensures proper handling.
- Before every use, the operator must check that the device is in perfect working condition.
- This product must not be used in places where there is a potential explosion risk. Besides, it must neither be used in an environment favouring combustion nor in a humid or excessively hot or cold location.

A.5 Safety instructions against risks due to electric currents

- The device must be connected to a grounded AC power outlet or a European standard outlet installed as per good professional practices.
- Before connecting the device, check that the power supply voltage and frequency match the specifications indicated on the device.
- Before powering, check that the device and cables are not damaged. Damaged cables and connections must immediately be replaced.
- Never allow the power cords to come in contact with other cables. Handle the power supply cable as well as all other cables connected to the mains with extreme care.
- Always connect the plug-in connector in the end. Ensure that the On/Off switch is in 'Off' position before connecting the device to the mains. The mains outlet must remain accessible after the installation.
- Check the device and its power supply cable from time to time. Disconnect the device from the mains when it is no longer used or for the purpose of maintenance.
- Handle the power cord by using the plug-in connector only. Never remove the plug-in connector by pulling the power cord.
- Electrical connection, repairs and maintenance must be carried out by qualified personnel.
- Do not switch on or switch off the device within a short span of time as this will reduce equipment life.

A.6 - Terms of use:

- This product has been designed for indoors use only.
- If this device has been exposed to very high temperature fluctuations (e.g.: after transportation), do not connect it immediately. The condensation formed inside the device could damage it. Allow the device to attain ambient temperature before connecting it.
- Do not shake the device, avoid sudden movements during its installation or handling.
- When selecting the spot for installation of the player, ensure that it is not exposed to a high source of heat, humidity or dust. There should not be any cables lying around as they might jeopardise your & others safety.

B. PRODUCT INFORMATION

B.1 Correct usage

The player is used to broadcast audio files automatically.

Correct usage involves compliance with the instructions given in this manual as well as with the requirements concerning installation.

B.2 Incorrect usage

Any other usage or usage beyond the scope of this application is considered as incorrect usage. The manufacturer shall not be liable for the damages ensuing from it. The user shall bear full responsibility for the risks incurred.

B.3 Delivery details

MicroPlayer mkIII

External power supply and its power supply cable

Remote control

User's manual

B.4 Specifications

Audio Player model : MicroPlayer mkIII

Nominal electrical values of the power supply connection

Voltage (V) 100 to 240

Frequency (Hz) 50-60

For details see Appendix B

B.5 Installation

The device must be installed in a dust free area.

Do not install the device directly against a wall. To avoid overheating, the ventilation openings must not be blocked. Take care to leave an empty space above the ventilation slits.

B.6 Electrical connection

Before activation, check whether the mains voltage matches with the voltage indicated on the rating plate.

1 - Présentation

MicroPlayer mkIII reads WAV and MP3 audio files. This standalone player can read files automatically according to a broadcast schedule or upon triggering by external events (input dry contact, RS232,...). Files are stored on a SD/SDHC memory card or on a USB flash drive.

MicroPlayer mkIII broadcasts music, sounds or messages in many environments like museums, showrooms, shop windows, attractions, touristic places, exhibitions..

2 - Functionalities

Interactivity: MicroPlayer mkIII is an interactive player that reacts depending on events.

- Playback pattern is defined by the name of files or folders
- Electrical contacts: 4 inputs combinable up to 15 inputs to trigger files through sensors, push-buttons, relays...
- 2 outputs can control Leds, relays, motors or any other external equipment thanks to Mosfet up to 500mA switch.
- Commands through the RS232 serial link. A simple protocol is used to send instructions to the player.
- Infrared sensor allows the use of a remote control.

Autoplay: MicroPlayer mkIII starts automatically on powering on. This function is configurable and can be disabled.

Playback: The audio files stored on a SD/SDHC memory card or USB flash drive can be organized in a particular way to define playback pattern. The playback pattern is defined by the names of the files and the folders, allowing a wide flexibility of use.

Audio output: 2 types of output are proposed.

- A line level stereo audio output on a RCA standard connector
- An amplified stereo output on a removable terminal block (RTB).

Power supply: A 12v external power supply is required.

The player is protected against polarity reversals and against usage, by mistake, of an alternative power supply instead of the D.C. power supply provided.

Caution! The player can accept a tolerance of the power supply voltage between 10 & 15V. Apart from this voltage range, the player can be damaged.

The input supply is transferred to the RS232 connector and the output terminal (RTB) to supply the connected accessories.

The power of the PSU determines the output power of the amplifier. When a line level output is used, a 500mA (6w) power supply is adequate to run on the player. When the amplified output is used for large powers, a supply of at least 3,45A(45w) is obligatory. If you use a PSU of an inferior power, you can have a very poor sound and also a overheating PSU till broken down.

Serial link RS232: MicroPlayer mkIII can be controlled by a PLC, a computer, a remote control using a serial link. MicroPlayer mkIII receives data on its Rx input and sends data on its Tx output. A specific protocol is described in this manual.

3 - INSTALLATION



- 1 - Amplifier volume
- 2 - General volume (configurable buttons)
- 3 - SD/SDHC memory card slot
- 4 - Infrared sensor
- 5 - Activity led

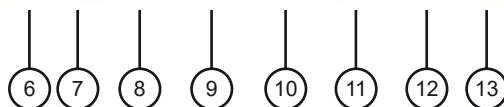
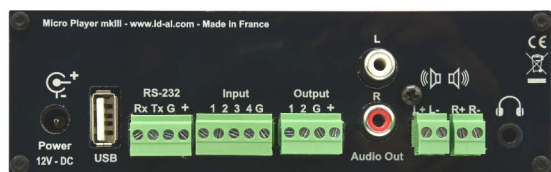

- 6 - Power of the supply of the player
- 7 - USB host for flash drive
- 8 - Serial link RS 232
- 9 - Inputs on dry contact
- 10 - Outputs on Mosfet
- 11 - Line level audio output
- 12 - Amplified outputs for speakers
- 13 - Headphone audio output

First use: MicroPlayer mkIII is factory setting configured with parameters by default and the player must operate on inserting a prepared media dedicated to (chapter 4).

Warning, before plug a SD/SDHC memory card or a USB flash memory, it is absolutely necessary to power off the player.

1 - Prepare and insert a quality SD/SDHC memory card or a USB flash memory.



SD/SDHC



OR

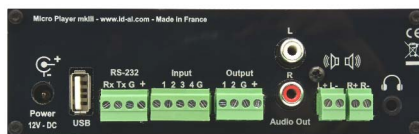

USB flash memory



Memory card: Choose a quality SD/SDHC, insert it in its slot till the stop without overdo. To remove, gently push on the memory card to unlock it.

USB connector: You can connect a USB flash drive

Note: If a SD/SDHC card and a USB flash drive are both connected, the SD/SDHC card will have priority and the USB stick will not be used

I.D. AL - MicroPlayer mkIII - Wav MP3 Audio player - User manual

2 - Connect speakers or a sound system to the audio output and switch on the player thanks to the PSU

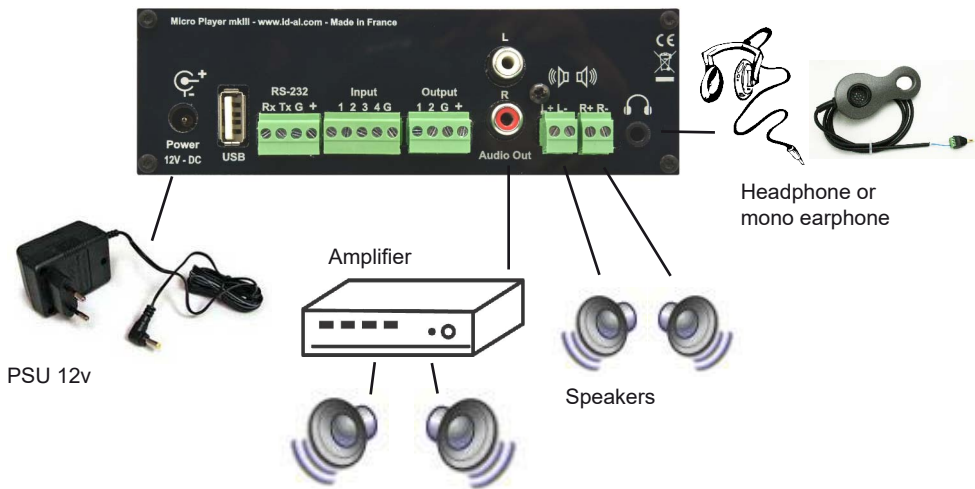

Power Supply Unit: We recommend you to use the PSU provided with the player. If you use another PSU or a battery, you have to respect the 12V specified voltage although the player can be power supplied between 10V and 15V. The power consumed depends on the power level of the amplifier.

Preparation of the medias:

Brand new SD/SDHC memory card and USB flash drive are usually «FAT» or «FAT32» formatted.

It is highly recommended to re-format your SD/SDHC card or USB flash memory. Select the FAT or FAT32 format depending on memory size (FAT32 above 512Mb). Other types of formatting do not work.

If you use Windows PC computer, latest versions do not allow to format high capacity medias (>32Go) system FAT32. In this case you must obtain a formatting software. Many software are available, some free, others paying that you will easily find on internet.

3.1 - Connections

3.1.1 - Inputs connections

Up to 4 triggerings, the connections are direct. Beyond it is necessary to make combinations with diodes. The inputs match with a binary representation of the files to be triggered. You can also use the optional extension card.

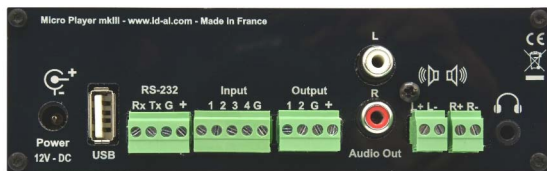

Optionnal extension board

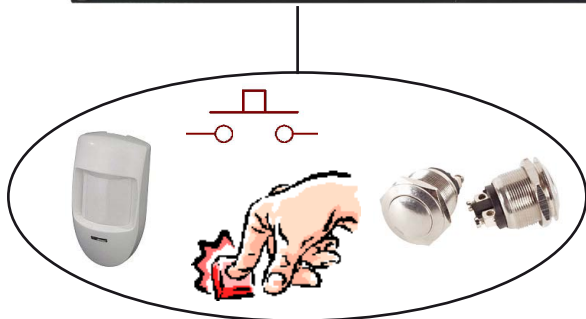

Internal input schematic

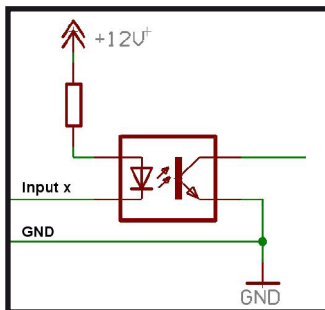

Example of a 15 inputs connection :

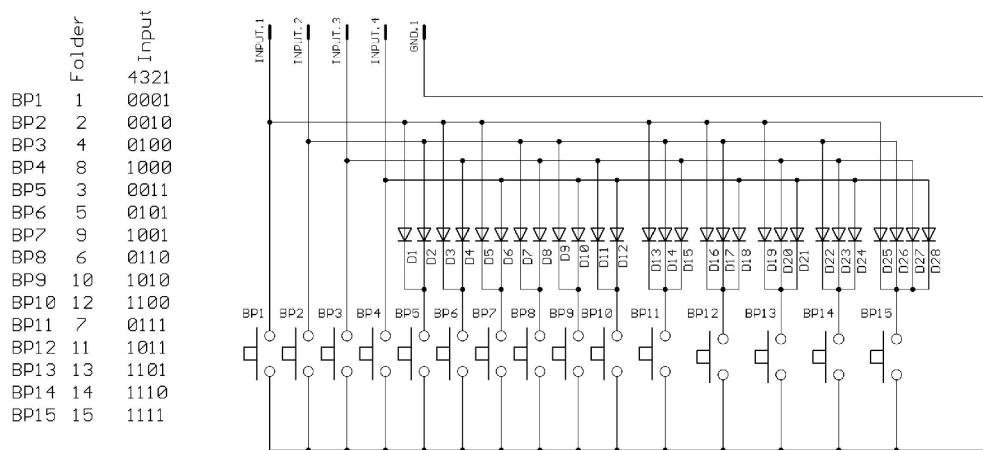

D1 - D28 - Diodes = 1N4148

MicroPlayer - 15 x push button

3.1.2 - Outputs connection

MicroPlayer mkIII offers 2 electronic switch outputs thanks to Mosfet transistors offering a switch power up to 500mA per output.

It is possible to connect Leds, motors, relays or any other compatible material.

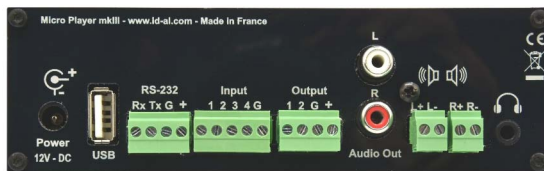

Note: V+ is a transfer of the PSU. With a 12V PSU, V+ will also be 12V. The provided power will not exceed 500mA.

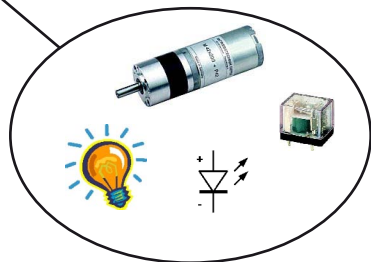

Internal Scheme of output of the player

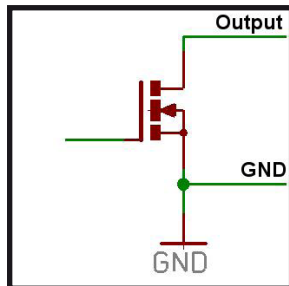

Example of a 2 inputs connection

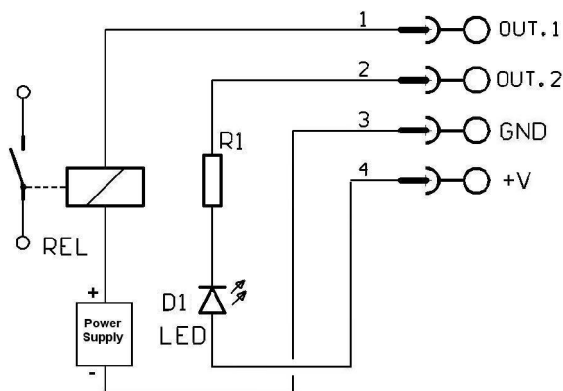

Switching features:

- Voltage Drain-Source max: 20V
- Power Drain-source max 500mA(2A en impulsion)
- Resistance switched Drain-Source 0,1 Ohms.

4 - Operating mode

Compatibles files:

.MP3: audio files MP3 format (see appendix B)

.WAV: audio filesWav format (see appendix B)

The file and folders names define the playback mode. The files and folders must be stored and copied according to a specific organisation described below.

4.1 Organisation of the folders:

Only ONE folder level is allowed at the root. The folder names are composed of 3 digits (000 to 999) followed by optional parameters and the name of your choice.

You should not use special or accentuated characters

Example :

001

003 [J002]

034 folder name

247 [V+02] [SEQ] my folder

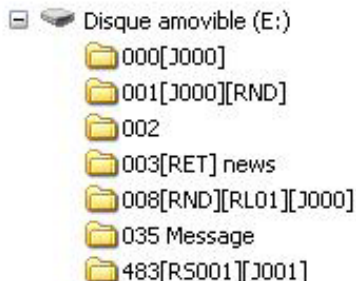

The folder number identifies the folder to use at the power on of the player, during a jump or an input triggering. You can use any number between 000 & 999.

● The first three digits represent the folder number and therefore its main name

Folders are numbered from 000 to 999.

Example :

000 : Folder N°000 - «Autoplay» folder which is automatically played when the device is powered on.

001 : Folder N° 1

034 : Folder N° 34

The folder number is used to define the playback order, it identifies the folder to use during a jump or an input triggering. You can use any number between 000 & 999.

IMPORTANT : The 4 input contacts allow the triggering of the folders numbers corresponding to these 3 digits, as per a binary order from 001 to 015. It is possible to modify the numbers of the triggered folders by editing file config.txt. (See chapter 5).

Folder 001- > Input 1

Folder 002 - >Input 2

Folder 003- > Input 1+2

Folder 004- > Input 3

Folder 005- > Input 1+3

Folder 006- > Input 2+3

Folder 007- > Input 1+2+3

Folder 008 - >Input 4

Folder 009 - >Input 1+4

Folder 010 - >Input 2+4

Folder 011 - >Input 1+2+4

Folder 012 - >Input 3+4

Folder 013 - >Input 1+3+4

Folder 014 - >Input 2+3+4

Folder 015 - >Input 1+2+3+4

Special case: Folder 000 is the folder which will be played by default when powering on. When powering on, presence of this folder is checked ; if it is present, the player plays files of this folder. If this folder is missing, the player turns in to stop mode.

Note: The folder which is read by default when powering on can be modified in the configuration menu. (see chapter 5)

Additional Parameters - Optional Tags:

To modify the conduct of the player, you can add optional parameters within the folder name. These parameters are boxed with the symbols «[« »]». You can add several parameters within the folder name.

[Jxxx] - Jump to another folder after reading the current folder or play in loop

[RET] - Returns to the previous folder after reading the current folder

[RND] ou **[SEQ]** - Specifies random or sequential playback mode for the current folder

[RLxy] - Activate the output contacts

[V+xx] ou **[V-xx]** - Controls the volume level of the folder

[NT] Or [DT] – Define interruption modes

[RSxxx] – Sending of RS232 codes

[WHL] - Play the folder during all the time that the corresponding inputs is activated

[NXTxxx] - Play a defined number of audio files from the folder

Note: If no optional parameter has been indicated, the player reads randomly the folder in full and then stops. The folder can be interrupted

● **[Jxxx]** – Assign the folder number to read after the reading the current folder.

By adding this parameter within the name of the folder, you define the conduct of the player after reading the current folder so that it starts reading another folder for example. This option is also used to read a folder in a loop mode.

The xxx parameter of the tag [Jxxx] is the number of folder to play. It is always written with 3 digits (example: 001, 045, 999). It is between 000 and 999.

Example:

001 [J002]: Jump to folder 002 after reading folder 001

003 [J003]: Jump to folder 003 after reading folder 003-> create a loop of the 003 folder

008 [J023]: Jump to folder 023 after reading 008

458[J999] : Jump to folder 999 after reading folder 458

To play loop files on powering on, you will use the folder 000 and the tag [J000] (value by default that can be modifiable through config.txt file - see chapter 5)

Example:

000[000]

● **[RET]** - Returns to the previously read folder after reading the current folder.

You are reading a folder. A command arrives in order to read another folder having [RET] tag. The player jumps in the new folder, reads the content of this new folder and once all files are read the player goes back to the reading of the previous folder. You can use this function to broadcast a same message after the reading of folders.

Several different folders can appoint a same folder in order to come back to the folder that has called him.

Example:

I.D. AL - MicroPlayer mkIII - Wav MP3 Audio player - User manual

001 [J100]: After reading folder 001, jumps to folder 100

002 [J100]: After reading folder 002, jumps to folder 100

100 [RET]:After reading folder 100, returns to the previous folder (001 or 002)

In the above example, after reading folders 001, 002, a jump to folder 100 is made to read the content. After reading folder 100, the reading occurs in the previous folder, it has to say the folder recently called.

Note : The [RET] tag has only one level of return. It is always the previous played folder that will be the returned folder.

● **[SEQ]** or **[RND]** - Specifies sequential playback mode of the current folder. By default or without parameter, the folder is read in a random mode.

[SEQ]: reading in a numerical order

[RND] or without any parameter : reading in a random mode

Example:

001 [SEQ]: read folder 001 in a sequential numerical order and stop at the end of the folder.

002[RND][J002]: reading of the folder 002 in a random mode and in a loop.

003[J001]: reading of the folder 003 in a random mode then jump to folder 001.

By choosing [SEQ] you select the sequential mode, meaning a reading in a defined order. The sorting is made through a numerical order it has to say in the order of the numeros of the names of the files. The files in the folder can be numbered from 001 to 999.(see next chapter related to files organisation within the folders for the naming details).

In a defined order [SEQ], the files which are not numbered are ignored.

● **[RLxy]** - Enable or disable the 2 output contacts

Each folder can directly activate different output contacts without any additional programming. You can switch on a light, motors or any other actions depending on the folder read.

[RLxy]: x,y represent the 2 outputs (x=output 1 – y= output2) and can accept 3 values

x or y = 0 : output is disabled

x or y = 1 : output is enabled during the reading of the current folder

x or y = 2 : output is permanently activated. An order is necessary to inactivate outputs.

Example :

000[RL00][J000]: the folder 000 is read in a loop on powering on. Outputs are disabled.

001[RL10][J000] : enable output 1 when the reading of the folder 001 occurs then go back to folder 000 with disabling output 1 after reading folder 001.

002[RL02][J003] : enable permanently the output 2 during the reading of the folder 002 then jump to folder 003 without disable the output 2.

Output contacts are switched from the beginning of the reading of the folder. If the files within the directory have an activation or inactivation option of the outputs contact, the different outputs will evolve.

Note: If a folder is played in a loop, the outputs whose state is set to 1 will be re-triggered at each loop of the folder. This mean a very short cut of the outputs designated to 1 at each loop-back.

Example:

001[J001][RL10]: Playback the folder 001 in a loop. At the end of the folder, output 1 will be deactivated then reactivated immediately.

- **[V+xx] ou [V-xx] – Volume folder setting**

The name of the folder can act on the output volume. This function is used to broadcast messages loud more or less than others files.

The increase or decrease of the volume by the volume tags is always done relatively the main volume. The xx parameter of the tag [V+xx] and [V-xx] is the number of volume steps to increase or decrease the main volume. It is always written with 2 digits (example: 01, 32, 64). It is between 00 and 64.

Example :

001[V+05]: increase the volume level from 5 steps during the folder playback

001[V-03] : decrease the volume level form 3 steps during the folder playback

At the end of the reading of the folder, the volume level goes back to its previous level.

- If the variation values exceed the minimum or maximum values of the player, the levels are settled to their maximum or minimum.

- **[NT] - This option defines the interruption mode of the folder currently read.**

If this option is registered in the folder name, the read file cannot be interrupted and instructions received are ignored.

Without this option, the reading of the currently read folder can be interrupted at any time by an external action. (input, RS232 ...)

Example:

001 [NT] - The folder can NOT be interrupted.

In that case, an action on one of the input contacts, through RS232 or other is ignored and the reading of the current file is not stopped. Caution! The action is not memorised and the triggering information is lost.

Note: the [NT] tag work exclusively on the change folder commands. The PLAY, STOP, NEXT FILE or PREVIOUS FILE commands are immediately executed.

- **[RSxxx] – This tag allows to send bytes onto the RS232 output.**

When the folder is called, a list of bytes is transferred by the serial link in order to control other devices (another player, switching grid, projector, ..) The bytes to send are included in a text file that will be especially created for.

Value by default : 19200 Bauds - 8 bits – no parity – 1 bit start – 1 bit stop

(modifiable through the config.txt file)

The xxx parameter of the tag [RSxxx] is the number of serial command to send (number of the line in the «serial.txt» file). It is always written with 3 digits (example: 001, 045, 999). It is between 001 and 999.

The file definition of the bytes to send must be named : serial.txt

This file will be copied at the root of the media (memory card/flash drive)

This file is a text file (raw text without page setting) that can be created with any easy text editor like «notepad» from windows or similar. When saving, use «ANSI» coding. Do not use special characters.

The file «serial.txt» of RS232 codes is a text file containing one or several lines. Each of these lines will include a sequence of bytes expressed in hexadecimal and separated by a space (from 00h to FFh). You must only indicate the two characters of the wished hexadecimal value.

I.D. AL - MicroPlayer mkIII - Wav MP3 Audio player - User manual

Each beginning of line of this file should present the following parameter:

#xxx : the xxx number of the line containing the bytes to send related to the xxx of the tag.

[RS002]-> line #002 – the tag [RS002] will send the sequence of bytes of the line #002 of the serial.txt file.

The separator between each byte is a space.

Example of a line contained in the serial.txt file.

```
#001: 45 85 63 21 78 A5 B2
```

```
#002: 98 75 21 35 45 98
```

```
#100: 21 35 45 78 A5 B2
```

It is also possible to add comments in the file by using two times the type «/» (slash)

```
// example file
```

```
#001: 05 A1 FF E4 // comment in the line
```

```
#005: 45 85 63 21 78 A5 B2
```

```
#100: 98 75 35 45 98 // my command
```

```
//other command
```

```
#064: 48 25 Ce 8b
```

```
#128: 4C 8E D9 5A //
```

```
#999: a4 Fc 48 3e 8B
```

```
// comments at the end of the file
```

An example to allow the triggering of the reading of the folder 001 of another MicroPlayer mkII.

```
#001: 80 01 01
```

Example of tag:

```
001[RS001]: Sending of the bytes of the line #001 of the file «serial.txt» on reading of the folder 001
```

```
002[RS064]: Sending of the bytes of the line #064 of the file «serial.txt» on reading of the folder 064
```

Note: If a folder is played in a loop, the RS232 message defined with the [RSxxx] tag will be send at each loop of the folder.

Example:

```
001[J001][RS099]: Playback the folder 001 in a loop. At each loop-back of the folder, the message described at line 099 of the file «serial.txt» will be send on the player's RS232.
```

● [WHL] - Play the folder during all the time that the corresponding inputs is activated

This tag allows you to play the contents of a folder as long as the corresponding input is activated. When the input associated with the folder is released, the player applies the output tags added to the folder name. As long as the corresponding input is activated, the folder is played in a loop.

Example:

```
001[WHL]: The folder 001 is played in a loop while the input 1 is activated. When the input 1 is released, the player STOP.
```

```
002[WHL][J045]: The folder 002 is played in a loop while the input 2 is activated. When the input 2 is
```

released, the player plays the folder 045.

003[WHL][J999]: The folder 003 is played in a loop while the inputs 1+2 are activated. When the inputs 1+2 are released, the player plays the folder 999.

The player's dry contact inputs may be associated, it means that any changes in the mix of inputs will be managed at any time by the player.

Example:

000[J000]: The folder 000 is played in a loop when the player is powered on.

001[WHL][J000]: The folder 001 is played in a loop while the input 1 is activated. If the input 2 is activated in addition to the input 1, the player plays the folder 003.

002[WHL][J000]: The folder 002 is played in a loop while the input 2 is activated. If the input 1 is activated in addition to the input 2, the player plays the folder 003.

003[WHL][J000]: The folder 003 is played in a loop while the inputs 1+2 are activated. If the input 1 is released, the player plays the folder 002. But, if the input 2 is released, the player plays the folder 001.

● [NXTxxx] - Play a defined number of audio files from the folder.

This setting allows you to play a certain number of audio files from the folder designated by this tag. When the number of audio files played in the folder is reached, the player applies the output tags added to the folder name. If the number of files requested by the tag [NXTxxx] is greater than the number of audio files in the folder, the player will loop-back in the folder as needed in order to play the exact number of audio files requested.

With this tag, the player memorize the audio files that are played. This means that the audio files already played by a previous command [NXTxxx] are not replayed if all audio files in the folder are not played.

The xxx parameter of the tag [NXTxxx] is the number of audio file to play in the designated folder. It is always written with 3 digits (example: 001, 045, 999). It is between 001 and 999.

Example:

001[NXT003]: 3 audio files are played in the folder 001, then the player STOP.

002[NXT001][J000]: 1 audio file is played in the folder 002, then the player plays the folder 000.

003[NXT005][RET]: 5 audio files are played in the folder 003, then the player plays the last folder called.

004[NXT001][SEQ][J000]: The next file is played in the folder 004 in sequential sort.

● Specific conduct:

- If a folder is missing but a command designates this folder, the playback is stopped.

-When triggering designating a folder that does not contain a file and if a name contains an optional tag, this option is executed. If no playback option (for example a jump)is indicated, the player turns into stop mode.

4.2 Organisation of files inside folders.

Like for folders, files name define the playback conduct.

Note: The naming of the files is free if the reading is in a random mode. («RND» option or no option in the folder name). In this case, all the files will be read and can be interrupted.

In a sequential mode, you should number the files. The names are composed of 3 digits (001 to 999) and of a name of your choice. Optional informations (tags) can be added following your need, like the interruption of the file or the triggering of the outputs.

Example:

001 [J367] my message.mp3
063 [RS020] file name.wav
845 [V+12][RL01] my file.mp3»
MY SONG [NT].wav

Two types of audio files can be used:

- . WAV audio files (.wav).
- . MPEG layer 3 audio files (.mp3).

For more information on the audio file type supported by your player, please refer to the Annex B of this manual.

Note: In sequential mode (SEQ), if numbered and non-numbered files are present, only the numbered files will be read. In random mode, all the files be read.

- **The first three digits represent the file number as its principal name from 001 to 999.**

Example:

001.mp3 - file No.001
063.wav - file No.063

If the folder indicates random mode [RND], the files don't have to be numbered and playback will be in random mode. In sequential mode [SEQ], file are read in the first three digits order and the non-numbered files are ignored.

Optional parameters

To modify the conduct of the player, you can add optional parameters in the file name. These parameters are boxed by the symbols «[» and «]». You can use several parameters in the file name.

[Jxxx] - Jump to a folder after reading the current file.

[NT] or **[DT]** - The file can not be interrupted or the action is memorised to be executed at the end of the file.

[RLxy] – Enables or disables output contacts

[RSxxx] – Sending of a sequence of bytes through RS232 link

[V+xx] or **[V-xx]** - Controls the volume level of the folder

Note: Without any option, the files are read the ones after the others according to the selected mode (random or sequential) and can be interrupted at any time by external action.

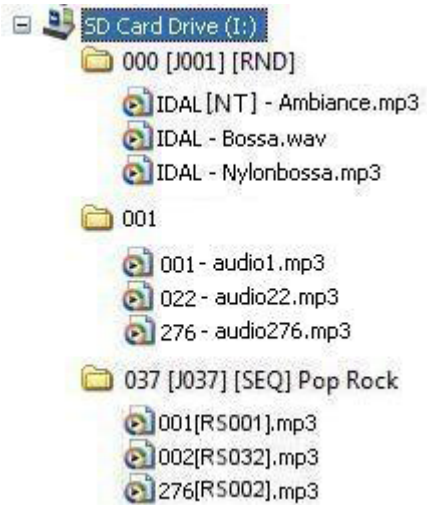

I.D. AL - MicroPlayer mkIII - Wav MP3 Audio player - User manual

- **[Jxxx] designates the folder number to use after reading the current file.**

By adding this parameter within the file name, you define the conduct of the player at the end of the reading of the current file in order to read another file.

- If the destination folder does not exist, the playback is stopped.
- If the designating folder does not contain a file and if a name contains an optional tag, this option is executed. If no option is indicated, the player turns into stop mode.

Example:

My file [J002].mp3 - Jumps to folder 002 after reading file.

003 [J023][RL02].mp3 - Enable output 2 and jumps to folder 023 after reading file 003.

034 [J034].wav - Jumps to folder 034 after reading the file. It's not a loop with the file 034 but a jump to folder 034.

This function allows for example to survey a file in order that he is followed by a Jump. Several files can designate the same directory of jump.

Example :

001[J100].mp3 – After the reading of the file 001, Jump into folder 100

002[J100].wav – After the reading of the file 002, Jump into the folder 100

- **[RLxy] enables or disables the 2 output contacts**

Each file can activate output contacts directly without any additional programming.

You can switch on lights, run a motor or any other action according to the files read.

[RLxy]:x,y represent the 2 outputs (x= output 1 – y = output 2) and can be from 3 values

x or y = 0 : output is disabled

x or y = 1 : output is enabled all along the reading of the current file.

x or y = 2 : output is permanently enabled. Another instruction is needed to disable outputs.

Example :

My file [RL00].mp3 : read the mp3 file. Outputs are disabled

001[RL10].wav – Enable output 1 during the reading of the file 001.wav then go on the reading of the following file with desactivating output 1.

Message[RL02].mp3 – Enable output 2 during the reading of the file then go on reading of the following file without disabling output 2.

004[RL21].wav – Enable the two outputs during the reading of the file 004.wav then go on the reading of the following file without disabling output 1 and with disabling output 2.

- **[NT] - This option defines the interruption mode of the file currently read .**

If this option is registered in the file name, the file cannot be interrupted and instructions received are ignored.

Without this option, reading of the current file can be interrupted at any time by an external action except if the option is included within the name of the file.

Example:

001 [NT].mp3 - The file can NOT be interrupted.

An action on one of the input contacts, through RS232 link or any other is ignored and the reading of the

I.D. AL - MicroPlayer mkIII - Wav MP3 Audio player - User manual

current reading is not stopped. Caution! The action is not memorised and the triggering information is lost.

The files that can be interrupted and those that can not be interrupted can coexist in the same folder.

Note: the [NT] tag work exclusively on the change folder commands. The PLAY, STOP, NEXT FILE or PREVIOUS FILE commands are immediately executed.

● [RSxxx] – This tag allows to send bytes through RS232 output.

This tag allows to send bytes onto the RS232 output. When the file is called, a list of bytes is transferred by the serial link in order to control other devices (another player, switching grid, projector..) The bytes to send are included in a text file that will be especially created for that purpose.

Value by default : 19200 Bauds - 8 bits – no parity – 1 bit start – 1 bit stop

(modifiable through the config.txt file - see chapter 5)

The xxx parameter of the tag [RSxxx] is the number of serial command to send (number of the line in the «serial.txt» file). It is always written with 3 digits (example: 001, 045, 999). It is between 001 and 999.

The file definition of the bytes to send must be named : serial.txt

This file will be copied at the root of the media (SD memory card or USB flash drive)

This file is a text file (raw text without page setting) that can be created with any easy text editor like «notepad» from windows or similar. On saving, use «ANSI» coding . Do not use special characters.

The file «serial.txt» of RS232 codes is a text file containing one or several lines. Each of these lines will include a sequence of bytes expressed in hexadecimal and separated by a space (from 00h to FFh). You must only indicate the two characters of the wished hexadecimal value.

Each beginning of line of this file should present the following parameter:

#xxx : xxx number of the line containing the bytes to send in connection with the xxx of the tag.

[RS002]-> The tag [RS002] will send the sequence of bytes of the line #002 of the «serial.txt» file.

The separator between each byte is a space.

Example of a line contained in the «serial.txt» file.

#001: 45 85 63 21 78 A5 B2

#002: 98 75 21 35 45 98

#100: 21 35 45 78 A5 B2

It is also possible to add comments within the file by using two times the type «/» (slash writer)

```
// example file
```

```
#001: 05 A1 FF E4 // comment in the line
```

```
#005: 45 85 63 21 78 A5 B2
```

```
#100: 98 75 35 45 98// my command
```

```
//other command
```

```
#064: 48 25 Ce 8b
```

```
#128: 4C 8E D9 5A //
```

```
#999: a4 Fc 48 3e 8B
```

```
// comments at the end of the file
```

An example to trigger the reading of the folder 001 of another MicroPlayer mkII.

#001: 80 01 01

Example of files:

001[RS001].mp3: Sending of the bytes of the line #001 of the «serial.txt» file on reading of the file 001

002[RS064].wav: Sending of the bytes of the line #064 of the «serial.txt» file on reading of the file 064

● [V+xx] or [V-xx] – file Volume setting

The name of the file can act on the output volume. This function is used to broadcast messages loud more or less than others files.

The increase or decrease of the volume by the volume tags is always done relatively the main volume.

The xx parameter of the tag [V+xx] and [V-xx] is the number of volume steps to increase or decrease the main volume. It is always written with 2 digits (example: 01, 32, 64). It is between 00 and 64.

Example:

001[V+05].mp3: increase the volume level from 5 steps during the file playback.

001[V-03].wav: decrease the volume level form 3 steps during the file playback.

At the end of the reading of the file, the volume level goes back to its previous level.

- If the variation values exceed the minimum or maximum values of the player, the levels are settled to their maximum or minimum.

Command line:

#VOLUME:xx xx = a value between 00 and 64

Example :

#VOLUME:18 the volume will be from 18 on powering

If the line is missing the last known value by the player will be used.

5.3 - Energy saving mode (stand by) - #POWER:x

MicroPlayer mkIII can turn into energy saving mode during its standby mode. It is possible to use a battery as a power source. The player turns into this mode automatically when he does not read a file. Only the input contacts are watched. When an input contact is detected, the player « wakes up » et and executes the command.

Note: When the folders contain numerous files, the waking time is lengthened.

Command line:

#POWER:x x = value 0 or1
 0 = normal mode without saving mode management
 1 = energy saving mode

Example : **#POWER:1** The player is in energy saving mode

If the line is missing, the factory setting value is used by default, it has to say 0, normal mode without energy saving management.

5.4 Configuration of the speed of the RS232 - #BAUDRATE:xxxx

By default, the serial link RS232 in and out is 19200 Bauds; With this option you can modify this value.

Command line:

#BAUDRATE:xxxx x = a value among 9600, 19200, 38400

Example :

#BAUDRATE:9600 The player send and receive at 9600 bauds.

If the line is missing, the factory setting by default is used it has to say 19200 bauds.

5.5 Monitoring of the player through RS232 - #RS_MONITORING:x

The MicroPlayer mkII has one serial input and one serial output RS232 standard.

This link can be used to control the player but also to watch him.

Four configurations are possible to define the kind of outgoing link.

● **Mode 0** : no monitoring , No data sent by the player

● **Mode 1** : «Daisy Chain» mode

This mode allows to chain up the players the ones after the others with only one RS232 link. The serial Tx output of a player is connected to a serial Rx input of the next one and so on. When the first player receives an instruction, this same instruction is sent to its output and so on. Caution , when numerous

players are chained up a latente period can exist at the end of the chain.

● **Mode 2:** Monitoring mode

In this mode, the player send onto its Tx serial output, some information on its status.(see previous chapter describing the procedure)

An external device can therefore receive informations to know if the player is in a reading mode or in a stop mode. These functions can be used to check the good functioning of the player.

● **Mode 3:** Advanced monitoring mode

The advanced mode has the same functions that the standard monitoring mode and the additional function is the regular sending of informations on its status. A frame is sent every 250 ms describing the status of the player among 3 possibilities:

- 1 - Stop - send a frame indicating that the player does not read and wait for a command
- 2 - Playback - send a frame indicating that the player reads a file
- 3 - Other -No frame sent : the player is not available. The memory card is missing or defective, power supply default or the player is out of order

This mode is used in a context of security message management. A frame fault reports an error and allows to intervene to solve the default.

Command line:

```
#RS_MONITORING:x          x = a value 0,1, 2 or 3
                           0 = no monitoring
                           1 = «daisy chain» mode
                           2 = monitoring mode
                           3 = advanced monitoring mode
```

Example :

```
#RS_MONITORING:1          The player is on «daisy chain « mode
```

If the line is missing , the factory setting value by default is used it has to say 0, no monitoring. See chapter 6 for informations on RS232 protocol.

5.6 - Choose of the playback folder when powering - #BOOT:xxx

Sometimes, it can be necessary to define the folder that will be played when powering. By default, the folder 000 is used as autoplay folder.

Command line:

```
#BOOT:xxx                xxx a number between 000 et 999
```

Example:

```
#BOOT:015                the player will read the content of the 015 folder when powering..
```

If the line is missing, the « factory setting» value by default will be used , 000 for the folder 000. If the folder does not exist , the player turns into stop mode and waits for an instruction

5.7 - Assign particular functions to the inputs - # INPUTxxx:function

By default, input contacts trigger folders in order to read their content. For a better versatility of the player, it is possible to assign input contacts to others functions.

List of commands :

PLAY : Reading known file

STOP : Stop the current reading

NEXT_TRACK : Reading of the next file of the folder currently read.

PREV_TRACK : Reading of the previous file of the folder currently read.

VOLUME_PLUS : Increase the volume from one step

VOLUME_MINUS : Decrease the volume from one step

FOLDERxxx : Jump to the folder xxx - xxx can be a value between 000 and 999

RSxxx : Send the line n° xxx of the file « serial.txt » on the output RS232 (with xxx from 000 to 999).

Command line :

#INPUTxx:function

xx on input from 01 to 15 - function among the list below

Example of a command keypad using the 4 inputs.

#INPUT01:PREV_TRACK	previous file playback
#INPUT02:STOP	stop the playback
#INPUT04:PLAY	launch playback
#INPUT08:NEXT_TRACK	next file playback

The 4 inputs are amongst themselves combinable in order to offer 15 different functions upon the following table below.

#INPUT01 ->	input 1
#INPUT02 ->	input 2
#INPUT03 ->	input 1+2
#INPUT04 ->	input 3
#INPUT05 ->	input 1+3
#INPUT06 ->	input 2+3
#INPUT07 ->	input 1+2+3
#INPUT08 ->	input 4
#INPUT09 ->	input 1+4
#INPUT10 ->	input 2+4
#INPUT11 ->	input 1+2+4
#INPUT12 ->	input 3+4
#INPUT13 ->	input 1+3+4
#INPUT14 ->	input 2+3+4
#INPUT15 ->	input 1+2+3+4

Example of functions with input contacts combination :

#INPUT03:RS001
#INPUT05:VOLUME_PLUS
#INPUT10:VOLUME_MINUS
#INPUT14:FOLDER999

5.8 - Assign particular functions to buttons - #BUTTONx:function

The two front buttons are dedicated by default to the volume setting. With the file «config.txt», it is possible to assign them other functions.

List of commands :

PLAY : Reading of the last known file

STOP : stop of the current reading

NEXT_TRACK : Reading of the next file of the folder currently read.

PREV_TRACK : Reading of the previous file of the folder currently read.

VOLUME_PLUS : Increase the volume from one step

VOLUME_MINUS : Decrease the volume from one step

FOLDERxxx : Jump to the folder xxx - xxx can be a value between 000 and 999

RSxxx : send the line n° xxx of the file « serial.txt » on the output RS232 (with xxx from 001 to 999).

Command line:

#BUTTONx:function x the number of the button 1 or 2 - function among the list below:

Example:

#BUTTON1:NEXT_TRACK The button 1 is assigned to the function « next file »

#BUTTON2:STOP The button 2 is assigned to the function « STOP »

Note: The buttons 1 and 2 of the infrared remote control do the same functions that the ones assigned respectively to front buttons 1 and 2.

Example of a configuration file (config.txt):

```
#ID:002
```

```
#VOLUME:48
```

```
# POWER:1
```

```
#BAUDRATE:9600
```

```
#RS_MONITORING:1
```

```
#BOOT:005
```

```
#INPUT01:PREV_TRACK
```

```
#INPUT02:STOP
```

```
#INPUT04:PLAY
```

```
#INPUT08:NEXT_TRACK
```

```
#BUTTON1:STOP
```

```
#BUTTON2:PLAY
```

In the following example, the configuration file «config.txt» affects to the player the following parameters:

- Id number of the player for the serial protocol = 002

- Player Volume at power on = 48

- Power saving mode = active

- Speed of the serial link = 9600 bauds

- «Monitoring» mode = Daisy Chain

- Autoplay folder at power on = 005

- Input 1 = Previous File

- Input 2 = Stop

- Input 3 (logical 4) = Play

- Input 4 (logical 8) = Next File

- Button 1 = Stop

- Button 2 = Play

I.D. AL - MicroPlayer mkIII - Wav MP3 Audio player - User manual

Function	Value	By default
#ID:xxx	xxx = from 001 to 127	001
#VOLUME:xx	xx = from 0 to 64	Last used value
#POWER:x	0 : Disable the energy saving mode 1: Enable the energy saving mode	0 (energy saving mode disable)
#RS_MONITORING:x	0: No sending mode 1: Daisy chain mode 2: Monitoring mode 3: Extended monitoring mode	0 (no sending data)
#BOOT:xxx	xxx = from 000 to 999	000 (folder 000)
#INPUTxx:fonction	xx = from 0 to 15 PLAY STOP NEXT_TRACK PREV_TRACK FOLDERyyy - yyy : 000 to 999 VOLUME_PLUS VOLUME_MINUS RSyyy - yyy: 001 to 999	INPUT01:FOLDER001 INPUT02:FOLDER002 INPUT03:FOLDER003 INPUT04:FOLDER004 INPUT05:FOLDER005 INPUT06:FOLDER006 INPUT07:FOLDER007 INPUT08:FOLDER008 INPUT09:FOLDER009 INPUT10:FOLDER010 INPUT11:FOLDER011 INPUT12:FOLDER012 INPUT13:FOLDER013 INPUT14:FOLDER014 INPUT15:FOLDER015
#BUTTONx:fonction	x = 1 or 2 PLAY STOP NEXT_TRACK PREV_TRACK FOLDERyyy - yyy : 000 à 999 VOLUME_PLUS VOLUME_MINUS RSyyy - yyy : 001 à 999	BUTTON1:VOLUME_MINUS BUTTON2:VOLUME_PLUS
#BAUDRATE:xxxxx	9600, 19200, 38400	19200 bauds

6 - RS232 serial link protocol

The MicroPlayer mkIII can communicate with other devices by receiving instructions onto the Rx input or transferring data through its Tx output. The player complies with the RS232 norm (see appendix for features).

Value by default: 19200 Bauds - 8 bits - no parity - 1 bit start - 1 bit stop
(modifiable through «config.txt» file)

6.1 - Reception Protocol

With the input protocol, the player can receive instructions to launch a folder playback or sets the volume. On the other hand, in a framework of the using of several players on the same link, the player answers its own number (defined in the file «config.txt», see chapter 5) or to a general command.

The reception protocol is made of a 3 bytes frame.

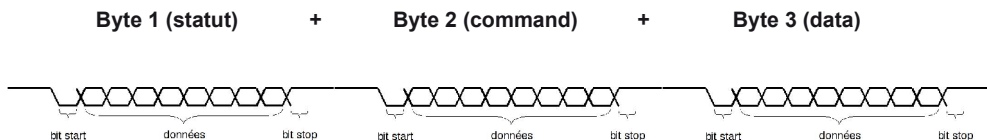

Reminder:

- a byte is composed of 8 bits: b7 b6 b5 b4 b3 b2 b1 b0
- a binary byte representation is noted: 1000000b or in hexadecimal : 80h

Byte 1 : Status - 1xxxxxxb

The byte status is a synchronization information of frame. Its bit 8 (b7) is always at 1. All others bits (commands or datas) have their bit 8 to 0.

b7 = 1: refer to a status bit

b6 - b0: identification of the player to be addressed from 001 to 127 (0000001b - 1111111b)

- The address of the player is by default (ID) 001. You can modify it in the config.txt file (see chapter 5)
- Several players may have the same identification number to create groups.
- Identification 000 is the «overall» address, all players are concerned by the command (unique command for all the players).

Example:

80h = «overall» address for all the players

81h = player n°001

9Eh = player n° 030

FFh = player n°127

Byte 2 (Command) 0xxxxxxb + Byte 3 (Data) 0xxxxxxb

The Byte 2 is a command and the byte3 is a data that completes the command byte. A command byte is always followed by a byte of data. A full frame is therefore made of 3 bytes.

b7 = 0 : refer to a byte of command or data

b6, b5, b4 : bank selection for the directory jump command

b3, b2, b1, b0 : command code sent to the player

List of commands:

00h: not used

X1h (01h to 71h): «Go to folder» command

02h: Player's transport command

03h: Volume command

● **00h - 00000000b: not used**

● **01h à 71h - 0xxx0001b: command of jump towards a folder**

The folder is designated by the bank number and the next data byte.

xxx is the bank number. To launch 1000 folders (from 000 to 999) , it is necessary to divide this number in several directory ranges (bank) of 128 values.

0xxx0001b: xxx= bank number depending of the folder number

01h - 00000001b: Bank 0 -> from 000 to 127

11h - 00010001b: Bank 1 -> from 128 to 255

21h - 00010001b: Bank 2 -> from 256 to 383

31h - 00110001b: Bank 3 -> from 384 to 511

41h - 01000001b: Bank 4 -> from 512 to 639

51h - 01010001b: Bank 5 -> from 640 to 767

61h - 01100001b: Bank 6 -> from 768 to 895

71h - 01110001b: Bank 7-> from 896 to 999

(The binaries values beyond 999 are ignored)

Method of calculation:

1) bank = value in the above table depending on the folder number

2) value = folder number - (bank number x 128)

Example of a frame triggering folder 278 in the player number 1:

Folder number = 278

1) 278 is in bank 2 (from 256 to 383)

2) Value = 278 - (2 x 128) = 22

The frame is: 81 21 16

Byte 1: 81h - 10000001b: status byte, player number 001

Byte 2 :21h - 00100001b: bank 2, command of jump towards a folder

Byte 3 :16h - 00010110b : value 22 (reference of folder 278 in bank 2)

● **02h - 00000010b: Player's transport command**

The transport function is defined by the data byte as follows:

Value of the datas of the byte 3 (data)

01h - 00000001b: Playback

02h - 00000010b: Stop

03h - 00000011b: Next file in the current directory

04h - 00000100b: Previous file in the current directory

Note: the other values are ignored.

Example of the full frame: 81 02 01

Octet 1 : 81h - 10000001b : status byte, player 001

Octet 2 : 02h - 00000001b : player's transport command

Octet 3 : 01h - 00000001b : playback command

● 03h - 00000011b: volume control command

The value of the volume is defined by the data byte that follows. Value are from 0 to 64:

00h - 00000000b : mute - volume at 0

20h - 00100000b : half volume - value 32

40h - 01000000b : maximum volume - value 64

Note : the values over 64 are ignored

Example of the full frame : 81 03 0E

Byte1 : 81h - 10000001b : status byte, player number 001

Byte2 : 03h - 00000011b : volume command

Byte3 : 0Eh - 00001110b : volume setting at 14

6.2 - Transmission Protocol - Monitoring

The MicroPlayer mkIII can send several kind of data onto RS232 port.

- Personalised data sent by tags [RSxxx] (see chapter «naming of files and folders»)
- Command datas of the player sent in «Daisy Chain» mode
- Status data of the player sent in mode «monitoring» and «advanced monitoring»

To define the kind of sent datas through RS232, 4 monitoring modes exist.

The monitoring mode is defined in the configuration file «config.txt» (see chapter 5).

The «Daisy Chain» mode and the monitoring mode are added up with the sending information mode through tags [RSxxx].

Mode 0: no monitoring mode

Only the data sent through tags [RSxxx] are sent to TX output.

Mode 1: «Daisy Chain»

In this mode, any information received on the Rx line is resent out as received onto the line Tx.

This mode allows to chain up several players the ones after to the others. By connecting Tx output of the first player to the Rx input of the second player and so on , the information received by the first player on its Rx socket is resent to the others players in chain. Caution ! if numerous players are connected in this way, a slight delay can exist on the end of the chain.

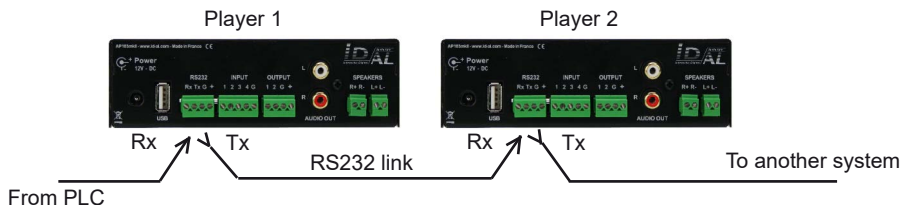

Mode 2: «Monitoring» mode

In this mode, the player send informations onto the Tx output depending on the actions executed. This mode do not allow to chain up the players. The player allows to a PLC, a computer, a security system, to know the status of the player and to make operating tests. In this mode, the player send data of its status upon each change.

The transmission protocol is made from a 3 bytes frame, similar to the reception protocol.

Byte 1: Status

>b7 = 1 : designates status byte

>b6 - b0 : designation of the sender player from 001 to 120 (0000001b - 1111111b)

The address (ID) of the player is by default 001 it has to say 81h. Modifiable in the config.txt file.

Byte 2 (Command)

Unique value : 00h - 00000000b

Byte 3 (Data)

00h - 00000000b : Player ready - The player reports that it is ready and available - when powering on, and operating.

01h - 00000001b : Not used

02h - 00000010b : Not used

03h - 00000011b : : Indicates the playback start - This code is sent when the player starts the playback

04h - 00000100b : Indicates end of playback - The player highlights it has finished the reading of the current file

Others values are not used.

Example of a process to check the good working of the player by reading an audio file.

Preparation: The player's number is 001

Create a folder «001» in which is copied an audio file»My file.mp3»

Launch folder 001 playback (with dry contact 1 trigger or with the sending of a command RS232).

When the player turns into playback, a frame is sent indicating the beginning of the playback:

81h 00h 03h

At the end of the playback, a frame is sent by the player indicating the end of the playback:

81h 00h 04h

Mode 3: «Advanced Monitoring» mode

The advanced mode have the same functions that the standard monitoring mode but adds a permanent sending function of its status. A frame is sent every 250ms describing the status of the player among two possibilities.

01h - 00000001b: sends a frame indicating that the player do not read and wait for an instruction.

02h - 00000010b: sends a frame indicating that the player reads a file.

This mode is used in a framework of security message management. A frame fault highlights an error and allows to solve the fault.

7 - Firmware Update

Logic and functionality of the player is defined by an internal program called «firmware». This program may evolve to provide new functionality, change the operation of the player or make corrections. The firmware can be updated or replaced by following these instructions:

The firmware upgrade is done from a SD memory card (SD or SDHC). The upgrade is not supported from a USB flash memory.

- On the www.id-al.com web site, download the firmware from the support page of the MicroPlayer mkII.
- Format your SD card in FAT32.
- Copy the file MPMK2.bin at the root directory of the SD card.
- Eject the SD card by using the ejection process of your OS.
- Turn off the MicroPlayer mkII.
- Put the SD card in the player and switch on. Please, wait until the activity LED of the MicroPlayer mkII turns green.
- At this time, the firmware update is finish. You can switch off the MicroPlayer mkII and remove the SD Card.

Appendix A - Characteristics

• Power supply:

Nominal voltage : 12V DC

Supply range : 9V to 14V DC

• 12V supply consumption:

- Stand By with active energy saving mode: 15 mA

- On operating (line output - amplified output not used) : 100mA

• Amplified audio output:

Voltage 12V - THD 1% - Load 4 Ohms: 2 x 15W

Voltage 12V - THD 10% - Load 4 Ohms: 2 x 19W

Voltage 12V - THD 1% - Load 8 Ohms: 2 x 8W

Voltage 12V - THD 10% - Load 8 Ohms: 2 x 10W

Size :

Width : 143mm (1/3 rack) - Height: 43mm

Depth without connectors: 66mm

Depth with connectors and button : 107mm

Weight : 240g

Table of equivalence of volume:

0	MUTE	22	-9,3dB	44	-3,3dB
1	-38,6dB	23	-8,9dB	45	-3,1dB
2	-31,2dB	24	-8,6dB	46	-2,9dB
3	-27,3dB	25	-8,2dB	47	-2,7dB
4	-24,6dB	26	-7,9dB	48	-2,5dB
5	-22,6dB	27	-7,5dB	49	-2,3dB
6	-20,9dB	28	-7,2dB	50	-2,2dB
7	-19,5dB	29	-6,9dB	51	-2,0dB
8	-18,3dB	30	-6,6dB	52	-1,8dB
9	-17,2dB	31	-6,3dB	53	-1,6dB
10	-16,3dB	32	-6,1dB	54	-1,5dB
11	-15,5dB	33	-5,8dB	55	-1,3dB
12	-14,7dB	34	-5,5dB	56	-1,2dB
13	-14,0dB	35	-5,3dB	57	-1,0dB
14	-13,3dB	36	-5,0dB	58	-0,9dB
15	-12,7dB	37	-4,8dB	59	-0,7dB
16	-12,1dB	38	-4,6dB	60	-0,6dB
17	-11,6dB	39	-4,3dB	61	-0,4dB
18	-11,1dB	40	-4,1dB	62	-0,3dB
19	-10,6dB	41	-3,9dB	63	-0,1dB
20	-10,2dB	42	-3,7dB	64	0,0dB
21	-9,7dB	43	-3,5dB		

Appendix B - Functionalities

Audio characteristics

- Reads MP3 files mono/stereo (MPEG ½ layer 3), 44.1KHz from 32kbit/s to 320kbits/s
- Reads CBR (Constant Bit Rate) and VBR (Variable Bit Rate) files
- Reads WAV files mono/stereo 16 bits : 44.1kHz
- Volume setting in 64 steps from 00 to 64

Note: Many professional software for composition and editing created some Broadcast WAV files instead of standard WAV files. The MicroPlayer mkII is not compatible with this type of file. Please follow the standard standard WAV files to ensure a perfect compatibility between your audio files and the specifications of the MicroPlayer mkII.

Mass storage

- Accept Flash SD/SDHC memory cards only formatted in FAT16 and FAT32
- Accept USB flash drive only formatted in FAT16 and FAT32
- Accept files with long names (63 characters max including extension)
- Accept 1000 folders at the root, containing up to 999 files each

Interfacing and connectivity

- 2 configurable buttons in front of the player
- LED status indicator
- Infrared sensor- Play, Stop, Next, Previous, Volume +, Volume -, 2 configurable buttons
- USB 2.0 Full Speed (12Mb/s), standard driver «mass storage», connector type B
- SD/SDHC Card connector
- Serial link RS232 - 19200 bauds (configurable), 8 bits, no parity, 1 bit start , 1 bit stop
- 4 digital inputs opto-coupled on removable terminal block **(RTB)** 3.81mm
- 2 digital output mosfet 500 mA on removable terminal block **(RTB)** 3.81mm
- A line level stereo audio output on a RCA standard connector – line level 0dB
- Amplified stereo output on a removable terminal block **(RTB)** 3.81 mm
- Amplified headphone output on mini-jack 3.5mm

Appendix C - Infrared remote control

The MicroPlayer mkII can be controlled with an infrared remote control as an infrared sensor is fitted in the front of the player.



With this remote control you can:

Transport command: Play / Stop / Next file / Previous file

Volume command: Change volume up/down

Triggering key: Same function than the front buttons 1 and 2 (configurable button).



**Design and manufacturing of interactive
audio and video players**

**Check our products, informations
and technical solutions on our web site:
www.id-al.com**