

4K@60/HDCP2.2 EDID emulator with Cable Equalizer

DDC-03UHD-A

<User Guide>

Ver.1.1.0

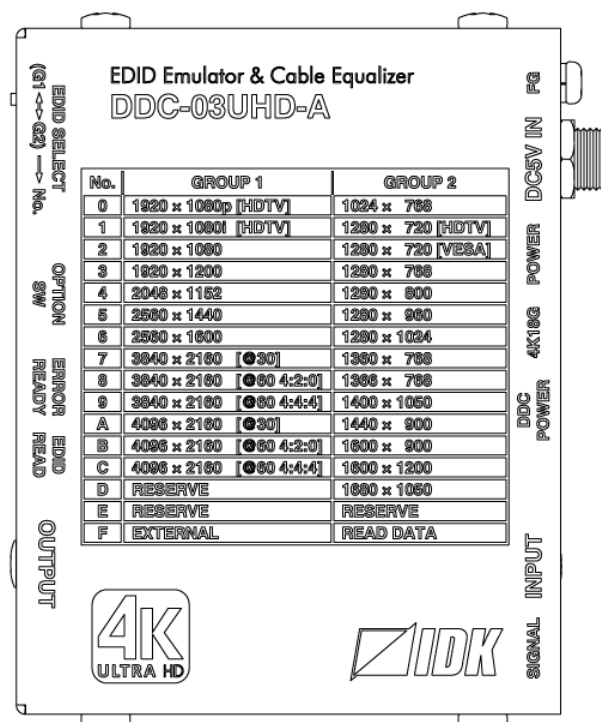

- Thank you for choosing our product.
- To ensure the best performance of this product, please read this user guide fully and carefully before using it and keep this manual together with the product for future reference as needed.

Trademarks

- Blu-ray Disc and Blu-ray are trademarks of Blu-ray Disc Association.
- The terms HDMI and HDMI High-Definition Multimedia Interface, and the HDMI Logo are trademarks or registered trademarks of HDMI Licensing Administrator, Inc. in the United States and other countries.
- Connection Reset is a registered trademark of IDK Corporation in Japan.
- All other company and product names mentioned in this manual are either registered trademarks or trademarks of their respective owners. In this manual, the “®” or “™” marks may not be specified.

Before reading this manual

- All rights reserved.
- Some information contained in this User guide such as exact product appearance, diagrams, menu operations, and so on may differ depending on the product version.
- This User guide is subject to change without notice. You can download the latest version from IDK's website at: <http://www.idkav.com>

FCC STATEMENT

This equipment has been tested and found to comply with the limits for a Class A digital device, pursuant to part 15 of the FCC Rules. These limits are designed to provide reasonable protection against harmful interference when the equipment is operated in a commercial environment. This equipment generates, uses, and can radiate radio frequency energy and, if not installed and used in accordance with the instruction manual, may cause harmful interference to radio communications. Operation of this equipment in a residential area is likely to cause harmful interference, in which case the user will be required to correct the interference at his own expense.

CE MARKING

This equipment complies with the essential requirements of the relevant European health, safety and environmental protection legislation.

WEEE MARKING











Waste Electrical and Electronic Equipment (WEEE), Directive 2002/96/EC
(This directive is only valid in the EU.)

This equipment complies with the WEEE Directive (2002/96/EC) marking requirement. The left marking indicates that you must not discard this electrical/electronic equipment in domestic household waste.

Safety Instructions

Read and understand all safety and operating instructions before using this product. Follow all instructions and heed all warnings/cautions.

Enforcement Symbol	Description
 Warning	Indicates the presence of a hazard that may result in death or serious personal injury if the warning is ignored or the product is handled incorrectly.
 Caution	Indicates the presence of a hazard that may cause minor personal injury or property damage if the caution is ignored or the product is handled incorrectly.



Symbol	Description	Example
 Caution	This symbol is intended to alert the user. (Warning and caution)	 Electrical Hazard
 Prohibited	This symbol is intended to prohibit the user from specified actions.	 Do not disassemble
 Instruction	This symbol is intended to instruct the user.	 Unplug

Warning





■ For lifting heavy products:

 Instruction	<ul style="list-style-type: none"> ● Lifting must be done by two or more personnel. <p>To avoid injury: When lifting the product, bend your knees, keep your back straight and get close to it with two or more persons.</p>
---	--

■ For installing and connecting products:

 Prohibited	<ul style="list-style-type: none"> ● Do not place the product upon a surface that may give way or that may become unstable. <p>Install the product in a secure and stable place to prevent it from falling and possibly causing injury.</p> <ul style="list-style-type: none"> ● Secure the product if installing in locations prone to vibration or movement. <p>Otherwise, it may move unexpectedly or it may fall and lead to injury.</p>
 Instruction	<ul style="list-style-type: none"> ● Installation work must be performed by professionals. <p>The product is intended to be installed by skilled technicians. For installation, please contact a system integrator or IDK. Improper installation may lead to the risk of fire, electric shock, injury, or property damage.</p> <ul style="list-style-type: none"> ● Insert the power plug into an outlet that is unobstructed. <p>Unobstructed access to the plug enables unplugging the product in case of any extraordinary failure, abnormal situation or for easy disconnection during extended periods of non-use.</p> <ul style="list-style-type: none"> ● Insert the power plug into an appropriate outlet completely. <p>If the plug is partially inserted, arcing may cause the connection to overheat, increasing the risk of electrical shock or fire. Do not use a damaged plug or connect to a damaged outlet.</p> <ul style="list-style-type: none"> ● Unplug the product from the AC power source during installation or service. <p>When connecting peripheral devices to this product, unplug all involved devices from outlets. Ground potential differences may cause fire or other difficulties.</p>

■ For operating products:

 Prohibited	<ul style="list-style-type: none"> ● Keep out any foreign objects. <p>To avoid fire or electric shock, do not permit foreign objects, such as metal and paper, to enter the product from vent holes or other apertures.</p> <ul style="list-style-type: none"> ● For power cable/ plug: <ul style="list-style-type: none"> • Do not scratch, heat, or modify, including splicing or lengthening them. • Do not pull, place heavy objects on them, or pinch them. • Do not bend, twist, tie or clamp them together forcefully. <p>Misuse of the power cable and plug may cause fire or electric shock. If power cables/plugs become damaged, contact your IDK representative.</p>
 Do not disassemble	<ul style="list-style-type: none"> ● Do not repair, modify or disassemble. <p>Since the product includes circuitry that uses potentially lethal, high voltage levels, disassembly by unauthorized personnel may lead to the risk of fire or electric shock. For internal inspection or repair, contact your IDK representative.</p>
 Do not touch	<ul style="list-style-type: none"> ● Do not touch the product and connected cables during electrical storms. <p>Contact may cause electric shock</p>
 Instruction	<ul style="list-style-type: none"> ● Clean the power plug regularly. <p>If the plug is covered in dust, it may increase the risk of fire.</p>

Warning

■ **If the following problem occurs:**





- **Unplug immediately if the product smokes, makes unusual noise, or produces a burning odor.**
If you continue to use the product under these conditions, it may cause electric shock or fire.
- **Unplug immediately if the product is damaged by falling or having been dropped.**
If you continue to use the product under these conditions, it may increase the risk of electrical shock or fire. For maintenance and repair, contact your IDK representative.
- **Unplug immediately if water or other objects are directed inside.**
If you continue to use the product under these conditions, it may increase the risk of electrical shock or fire. For maintenance and repair, contact your IDK representative.



Caution

■ For installing and connecting products:

 <p>Prohibited</p>	<ul style="list-style-type: none"> ● Do not place the product in a location where it will be subjected to high temperatures. If the product is subjected to direct sunlight or high temperatures while under operation, it may affect the product's performance and reliability and may increase the risk of fire. ● Do not store or operate the product in dusty, oil smoke filled, or humid place. If the product is placed near humidifiers or in a dusty area, it may increase the risk of fire or electric shock. ● Do not block the vent holes. If ventilation slots are blocked, it may cause the product to overheat, affecting performance and reliability and may increase the risk of fire. ● Do not place or stack heavy items on the product. Failure to observe this precaution may result in damage to the product and other property and may lead to the risk of personal injury. ● Do not exceed ratings of outlet and wiring devices. Exceeding the rating of an outlet may increase the risk of fire and electric shock.
 <p>No wet hands</p>	<ul style="list-style-type: none"> ● Do not handle power plug with wet hands. Failure to observe this precaution may increase the risk of electrical shock.
 <p>Instruction</p>	<ul style="list-style-type: none"> ● Use and store the product within the specified temperature/humidity range. If the product is used outside the specified range for temperature and humidity continuously, it may increase the risk of fire or electric shock. ● Do not place the product at elevations of 1.24 mi. (2,000 m) or higher above sea level. Failure to do so may shorten the life of the internal parts and result in malfunctions. ● When mounting the product into the rack, provide sufficient cooling space. Mount the product in a rack meeting EIA standards, and maintain spaces above and below for air circulation. For your safety as required, attach an L-shaped bracket in addition to the panel mount bracket kit to improve mechanical stability. ● Never insert screws without the rubber feet into the threaded holes on the bottom of the product. Never insert screws without the rubber feet into the threaded holes on the bottom of the product. Doing so may lead to damage when the screws contact electrical circuitry or components inside the product. Reinstall the originally supplied rubber feet using only the originally supplied screws.

■ For operating products:



 <p>Prohibited</p>	<ul style="list-style-type: none"> ● Use only the supplied power cable and AC adapter. ● Do not use the supplied power cable and AC adapter with other products. If non-compliant adapter or power cables are used, it may increase the risk of fire or electrical shock.
 <p>Unplug</p>	<ul style="list-style-type: none"> ● If the product won't be used for an extended period of time, unplug it. Failure to observe this precaution may increase the risk of fire. ● Unplug the product before cleaning. To prevent electric shock.
 <p>Instruction</p>	<ul style="list-style-type: none"> ● If cooling fan stops, power off the product and contact us. Failure to do so may rise internal temperature and increase the risk of malfunction, fire, or electric shock. ● Clean the vent holes regularly. If the vent holes of the cooling fan is covered in dust, internal temperature rises and it may increase the risk of malfunction, fire, or electric shock.

Table of Contents

1	Included Items.....	9
2	Product Outline	10
3	Features.....	11
4	Panels	12
5	Application Example	14
6	Precautions	15
6.1	Installation.....	15
6.1.1	Mounting the DDC-03UHD-A to wall or ceiling	15
6.2	Cabling.....	16
6.2.1	Cables	17
6.2.2	AC adapter with screw locking mechanism	18
7	Basic Operation	19
7.1	Built-in EDID	21
7.1.1	Supported Resolution.....	21
7.1.2	Selecting Built-in EDID.....	23
7.2	Using Copied EDID.....	24
7.2.1	Setting Copied EDID	24
7.2.2	Outputting video and audio using Copied EDID	26
7.2.3	Deleting Copied EDID	27
7.3	Using External EDID.....	28
7.3.1	Setting External EDID	28
8	DIP Switch.....	30
8.1	Input Equalizer	30
8.2	Output equalizer.....	31
8.3	Audio input Enabled/Disabled.....	31
8.4	HDCP input Enabled/Disabled.....	32
8.5	No-signal input monitoring	33
9	Specification.....	34
10	Troubleshooting	35

1 Included Items

Ensure that all items illustrated below are included in the package.
 If any items are missing or damaged, please contact IDK.

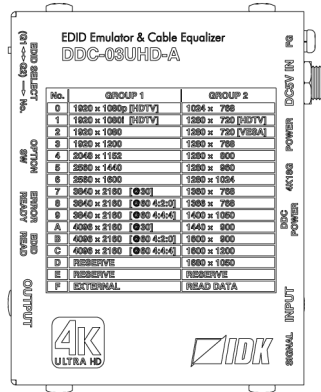

One (1) DDC-03UHD-A

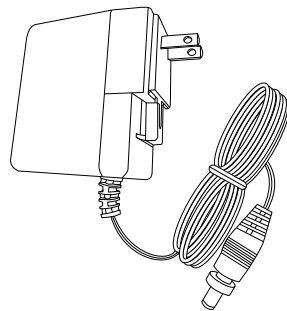

One (1) AC adapter 5.9 ft. (1.8 m) with screw locking mechanism

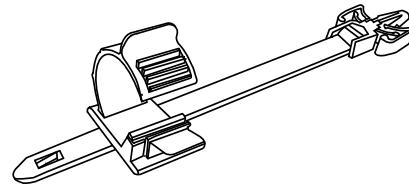

Two (2) Cable clamps

[Fig. 1.1] Included items

2 Product Outline

The IDK DDC-03UHD-A is a 4K@60 and HDCP 2.2 supported EDID emulator. The emulation feature enables a source device to output video and audio that are optimal for the monitor's functions and performance when the source device, such as PC and Blu-ray player, is connected to monitor.

The input cable equalizer and CDR (Clock Data Recovery) that reclocks input signals degraded by HDMI cables.

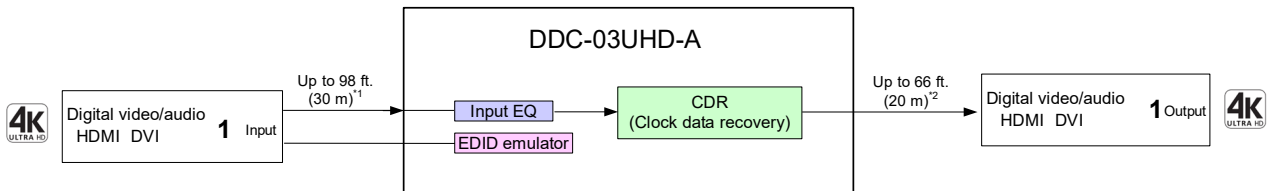

¹ The maximum transmission distances
 98 ft. (30 m): 1080p@60
 39 ft. (12 m): 4K@60 (When 18 Gbps high-speed transmission cable is used.)

² The maximum transmission distances
 66 ft. (20 m): 1080p@60
 26 ft. (8 m) : 4K@60 (When 18 Gbps high-speed transmission cable is used.)

[Fig. 2.1] DDC-03UHD-A diagram

Normally, the source device acquires EDID of the connected monitor to output optimal video and audio, but in some cases, appropriate EDID cannot be acquired. For example, if the source device has problems for acquiring the monitor's EDID or if the characteristics of the source device and monitor are not the same, the problem occurs. In such cases, the DDC-03UHD-A sets EDID in place of the monitor to avoid problems.

For PCs, the timing of acquiring EDID differs between Desktop PC and laptop PC.

- A desktop PC is connected to a monitor without the DDC-03UHD-A:
The desktop PC acquires EDID at the time of startup or connection and then outputs video and audio.
- A laptop PC is connected to an external monitor:
The laptop PC acquires EDID at the time of output setting of the external monitor and then outputs video and audio.

The DDC-03UHD-A is connected between a source device and monitor: The source device acquires EDID and then outputs video and audio when the DDC-03UHD-A's EDID setting is changed.

Built-in EDID, copied EDID, and external EDID can be set. See "**7 Basic Operation**" for details.

3 Features

As explained in the second chapter, the DDC-03UHD-A includes EDID emulation function as an extender. For video, 4K@60Hz (4:4:4) and HDCP 2.2, HDR, 3D, and x.v.Color are supported. For audio, at the time of built-in EDID selection, it is possible for audio not to be output from the source device by disabling the audio information of the selected EDID.

■ Video

- Up to 4K@60 (4:4:4)
- HDCP 1.4/2.2 (Pass-through)
- HDR
- 3D
- x.v.Color
- Automatic input signal equalization
 - Input Up to 98 ft. (30 m): 1080p@60
 - Up to 39 ft. (12 m): 4K@60 (when cable supporting 18 Gbps transmission is used)

■ Audio

- Audio input enabled/disabled

■ Others

- EDID emulation
 - Built-in EDID, copied EDID, and External EDID
- CDR (Clock Data Recovery)
- CEC (Pass-through)
- DDC buffer
- HDCP input enabled/disabled
- Connection Reset pass-through*
- AC adapter with locking mechanism

* Connection Reset pass through:

For digital systems, some problems, such as an HDCP authentication error, can often be recovered by physically disconnecting and reconnecting the digital cables. The Connection Reset feature will fix these problems automatically without the need to physically plug and unplug the cables. The DDC-03UHD-A passes through the Connection Reset function. If other devices are connected between the DDC-03UHD-A and the sink device, this feature may be invalid.

4 Panels

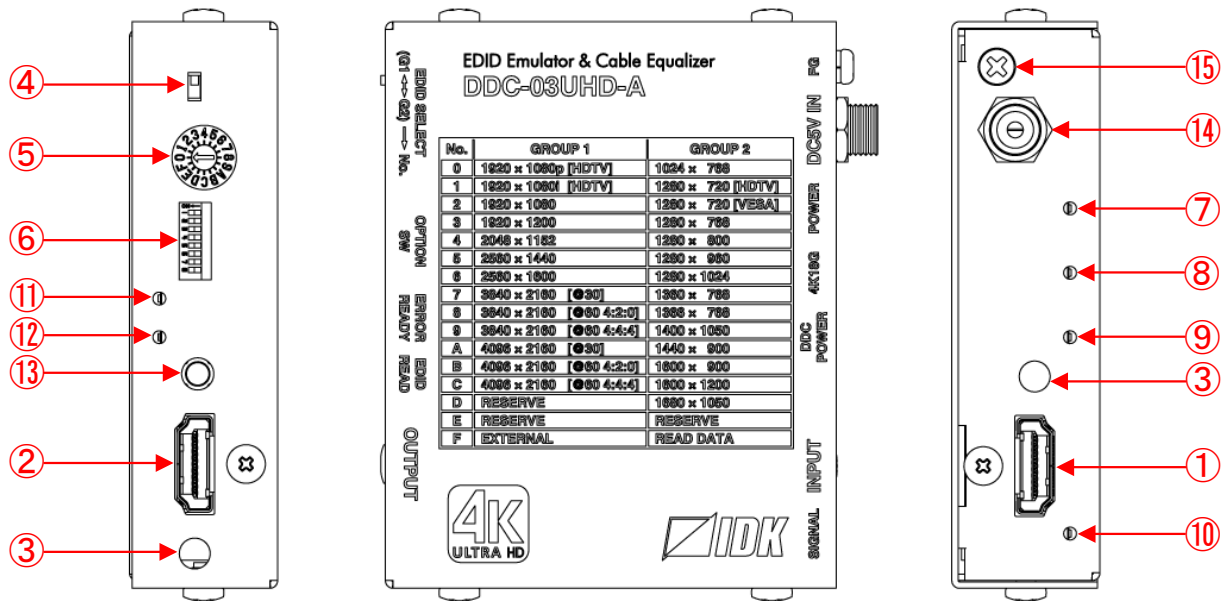

[Fig. 4.1] Panel drawings

[Table 4.1] Panel features

#	Feature	Description
①	HDMI input connector	Input connectors for HDMI and DVI signal to interface source devices, such as Blu-ray® players.
②	HDMI output connector	Output connector for HDMI and DVI signal to interface sink devices such as LC monitors and projectors
③	HDMI cable fixing hole	Retains HDMI cables by inserting cable clamps. 【See: [Fig. 6.2] Attaching cable clamp】
④	EDID slide switch	Selects an EDID group, GROUP 1 (G1) or GROUP 2 (G2). 【See: 7 Basic Operation】
⑤	EDID rotary switch	Selects an EDID in the selected group. Also used for acquiring the connected monitor's EDID to copy the data. 【See: 7 Basic Operation】
⑥	DIP switch	Sets equalizer, audio input enabled/disabled, HDCP input enabled/disabled, and No-signal input monitoring. 【See: 8 DIP Switch】

[Table 4.2] Panel features (Cont'd)

#	Feature	Description
⑦	POWER LED	Indicates the power status of the DDC-03UHD-A. Illuminating green : Power is connected. Does not illuminate : Power is not connected.
⑧	4K6G LED	Indicates the HDMI signal input status of transmission speed 18 Gbps that is sent from a source device. Illuminating green : Input (18 Gbps) Does not illuminate : Not input (slower than 18 Gbps or no HDMI signal is input)
⑨	DDC POWER LED	Indicates the DDC power status that is supplied from a source device. Illuminating green : Power is supplied. Does not illuminate : Power is not supplied.
⑩	SIGNAL LED	Indicates the HDMI or DVI signal input status that is sent from a source device. Illuminating green : Input. Does not illuminate : Not input.
⑪	ERROR LED	Indicates the EDID's access result and the presence of recorded EDID. Illuminating red : Reading EDID failed or EDID is being deleted. Flashing red : For copied EDID : No EDID is recorded. For external EDID : EDID cannot be read, because no cable is connected to the HDMI input connector or HDMI output connector. Does not illuminate : For copied EDID : EDID is recorded. For other EDID : No error (not depend on copied EDID status)
⑫	READY LED	Indicates the EDID access status (copying EDID from monitor or saving EDID in the DDC-03UHD-A). Illuminating green : No access to EDID.. Does not illuminate : Being accessed to EDID.
⑬	EDID READ button	Copies and records EDID of a monitor. Deletes a copied EDID.
⑭	AC power inlet	For use with provided power cable 【See: 6.2.2 AC adapter with screw locking mechanism】
⑮	Frame ground	Use for bonding chassis to local ground. M3 screws are used.

5 Application Example

■ Example 1: Using the DDC-03UHD-A as an EDID emulator

A switcher without EDID emulator is used after the DDC-03UHD-A. The source device outputs video at the optimal resolution to the monitor by using the EDID of the DDC-03UHD-A that is installed before the switcher. Select Built-in EDID or copied EDID.

The source device is able to acquire the monitor's EDID by using the EDID that is copied from the monitor. **【See: [Table 7.1] EDID】**

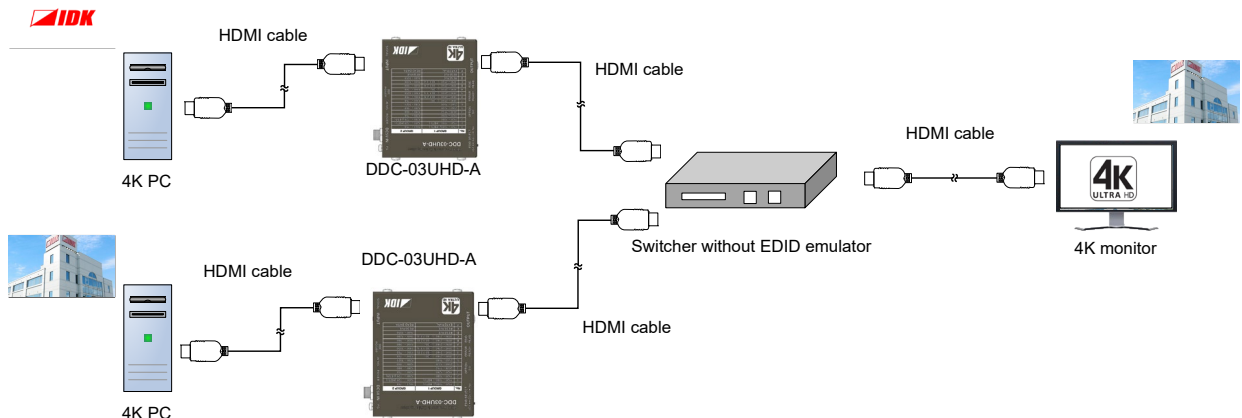

[Fig. 5.1] Application example 1

■ Example 2: Using the DDC-03UHD-A as an extender

The DDC-03UHD-A is used between a Blu-ray player and monitor.

Since the DDC-03UHD-A includes an equalizer in the input side, a Blu-ray player can be placed up to 98.4 ft. (30 m) (1080p@60) from the DDC-03UHD-A.

Select the EDID from Built-in EDID, copied EDID, and external EDID. If the monitor needs to be connected to , use External EDID to skip the EDID reset procedure.

【See: [Table 7.1] EDID】

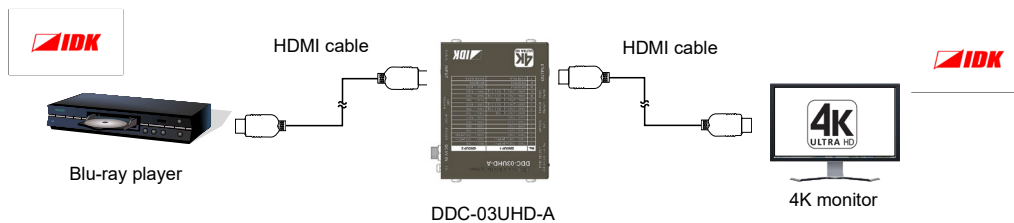

[Fig. 5.2] Application example 2

6 Precautions

Before connecting to external devices, follow the precautions below.

6.1 Installation

When installing the DDC-03UHD-A, please observe the following precautions.

- Do not stack or place one DDC-03UHD-A directly on top of another DDC-03UHD-A.
- Do not clog vent holes.
To provide adequate ventilation, maintain sufficient clearances around the DDC-03UHD-A (1.2 in. (30 mm) or more).
- When the DDC-03UHD-A needs to be mounted in an EIA rack or an enclosed space, ensure that sufficient ventilation or cooling is provided and that the ambient temperature will not exceed 104°F (40°C). If inadequately vented, the product's service life, operation and reliability may be affected.

6.1.1 Mounting the DDC-03UHD-A to wall or ceiling

The DDC-03UHD-A can be mounted to wall or ceiling using optional mounting kit FP-100 as shown below:

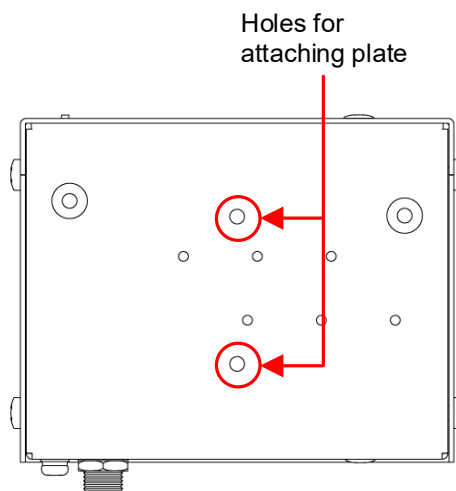

[Fig. 6.1] Holes for attaching plate

6.2 Cabling

When connecting the DDC-03UHD-A to external devices, observe the following precautions.

- Read manuals for the external devices.
- Before you connecting cables to the DDC-03UHD-A or an external device, dissipate static electricity by touching grounded metal such as racks before handling signal cables. Failure to observe this precaution may result in ESD (electrostatic discharge) damage.
- Power all units off before connecting cables.
- Be sure to fully seat all plugs and connections and dress cables to reduce stress on connectors.
- Secure HDMI cables using cable clamps to prevent connectors from being accidentally pulled out of ports.

Fixing HDMI cable using cable clamp

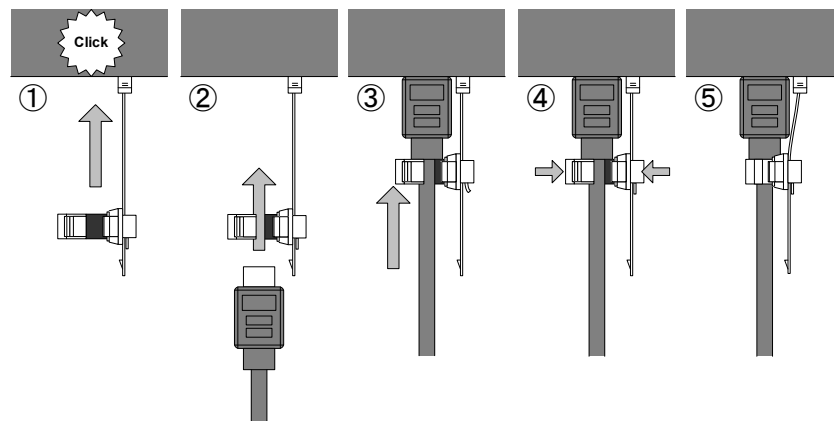

Removing HDMI cable and cable clamp

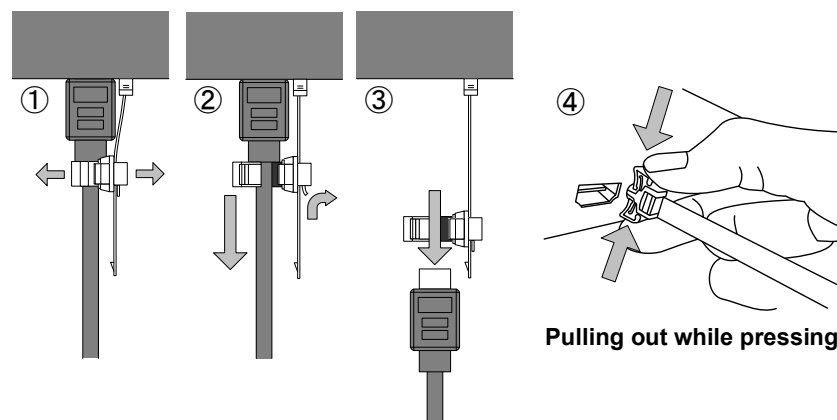

[Fig. 6.2] Attaching cable clamp

6.2.1 Cables

If the video is 4K format, the TMDS data rate (transmission speed) is 18 Gbps at maximum. If a high-speed HDMI cable, the TMDS data rate becomes 10.2 Gbps at maximum, and video cannot be displayed stably. Use an 18 Gbps high-speed cable according to each 4K format.

The maximum distance varies depending on the cable type, characteristics of the source device and monitor; the best cable for each format is recommended.

[Table 6.1] 18 Gbps high-speed cable for 4K format

4K Format	TMDS Data rate (Gbps)								
	RGB, YCbCr 4:4:4			YCbCr 4:2:2			YCbCr 4:2:0		
	24 bit	30 bit	36 bit	24 bit	30 bit	36 bit	24 bit	30 bit	36 bit
3840x2160p (24/25/30)	10.2 Gbps	18 Gbps	18 Gbps	10.2 Gbps	10.2 Gbps	10.2 Gbps	—	—	—
4096x2160 (24/25/30)	10.2 Gbps	18 Gbps	18 Gbps	10.2 Gbps	10.2 Gbps	10.2 Gbps	—	—	—
3840x2160p (50/59.94/60)	18 Gbps	—	—	18 Gbps	18 Gbps	18 Gbps	10.2 Gbps	18 Gbps	18 Gbps
4096x2160 (50/59.94/60)	18 Gbps	—	—	18 Gbps	18 Gbps	18 Gbps	10.2 Gbps	18 Gbps	18 Gbps

18 Gbps: 18 Gbps high-speed transmission cable, 10.2 Gbps: 10.2 transmission cable, —: N/A

Note:

If a cable joint (JJ) or the like is used and a cable is extended, video may be interrupted or not be output.

6.2.2 AC adapter with screw locking mechanism

The shapes of AC plugs with screw locking mechanism vary from country to country. The AC plug can be removed from the AC adapter.

Removing AC plug:

Slide the AC plug (②) from the AC adapter while holding down the portion mentioned below (①).

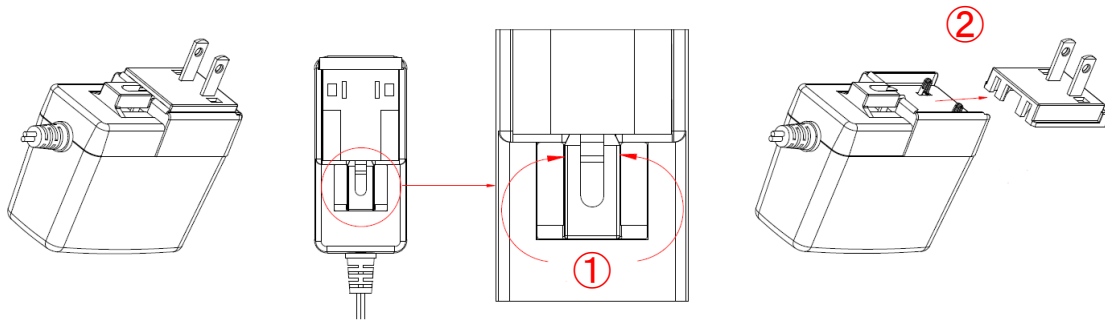

[Fig. 6.3] Removing AC plug (Example: Plug type A)

Attaching AC plug:

Gently slide the AC plug into the AC adapter (③) until it clicks (④).

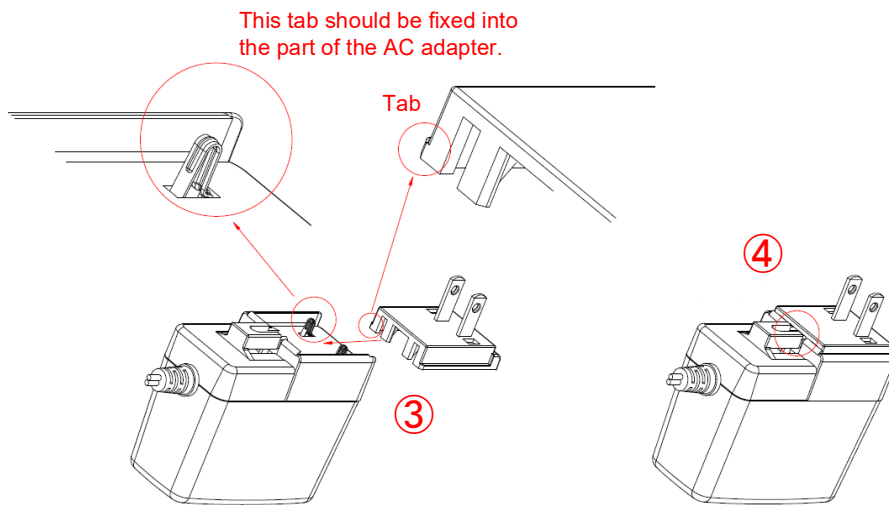

[Fig. 6.4] Attaching AC plug (Example: Plug type A)

7 Basic Operation

There are three types of EDID that can be set in the DDC-03UHD-A: Built-in EDID, Copied EDID, and External EDID. The EDID is divided into GROUP 1 and GROUP 2.

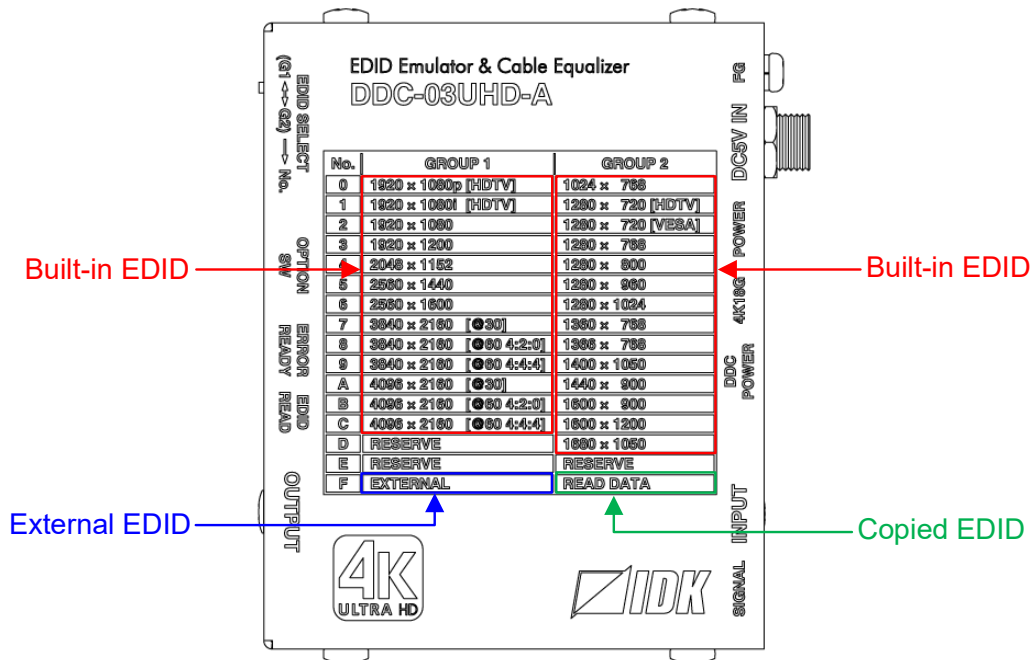

[Fig. 7.1] Grouping EDID

[Table 7.1] EDID can be set in DDC-03UHD-A

EDID type	Description	Page
Built-in EDID	Pre-programmed EDID in the DDC-03UHD-A. Use for outputting video and audio that are optimal for monitor's EDID.	21
Copied EDID	EDID that is copied from a monitor. Use if a monitor has EDID that is not in the Built-in EDID. Use if a source device cannot acquire monitor's EDID correctly when another device is connected between the DDC-03UHD-A and monitor. If EDID supports Deep Color, HDR, or compressed audio, the source device outputs the optimal video and audio.	24
External EDID	EDID that is acquired from a monitor connected to the DDC-03UHD-A. Use if the connected monitor needs to be changed. After monitor is changed and the DDC-03UHD-A's EDID is set to External EDID, the DDC-03UHD-A acquires the EDID of the new monitor. If EDID supports Deep Color, HDR, or compressed audio, the source device outputs the optimal video and audio.	28

■ Grouping

【GROUP 1】

No.	Pixel	Resolution
0	1920 x 1080p [HDTV]	1080p
1	1920 x 1080i [HDTV]	1080i
2	1920 x 1080	VESAHD*
3	1920 x 1200	WUXGA*
4	2048 x 1152	QWXGA*
5	2560 x 1440	WQHD*
6	2560 x 1600	WQXGA*
7	3840 x 2160 [@30]	4K@30 (3840 x 2160)
8	3840 x 2160 [@60 4:2:0]	4K@60 (3840 x 2160)
9	3840 x 2160 [@60 4:4:4]	4K@60 (3840 x 2160)
A	4096 x 2160 [@30]	4K@30 (4096 x 2160)
B	4096 x 2160 [@60 4:2:0]	4K@60 (4096 x 2160)
C	4096 x 2160 [@60 4:4:4]	4K@60 (4096 x 2160)
D	RESERVE	—
E	RESERVE	—
F	EXTERNAL	—

【GROUP 2】

No.	Pixel	Resolution
0	1024 x 768	XGA
1	1280 x 720 [HDTV]	720p
2	1280 x 720 [VESA]	VESA720
3	1280 x 768	WXGA
4	1280 x 800	WXGA
5	1280 x 960	Quad-VGA
6	1280 x 1024	SXGA
7	1360 x 768	WXGA
8	1366 x 768	WXGA
9	1400 x 1050	SXGA+
A	1440 x 900	WXGA+
B	1600 x 900	WXGA++
C	1600 x 1200	UXGA
D	1680 x 1050	WSXGA+
E	RESERVE	—
F	READ DATA	—

*VESAHD / WUXGA / QWXGA / WQHD / WQXGA: Reduced Blanking

7.1 Built-in EDID

Since video and audio information are registered in the Built-in EDID, audio that is output from the source device can be controlled.

【See: 8.3 Audio input Enabled/Disabled】

7.1.1 Supported Resolution

The Built-in EDID is divided into GROUP 1 (No.0 to No.C) and GROUP 2 (No.0 to No.D).

Select the resolution that is optimal for the desired monitor. The EDID supports the selected resolution and smaller resolution. Source devices supporting Plug and Play output video at the selected resolution or close resolution. The resolution depends on the source device; the resolution shown in the table below is not necessarily correct. Video may not be displayed correctly for some combinations of source device and monitor. The following table is for your reference only.

[Table 7.2] Supported resolution of Built-in EDID (GROUP 1)

S: Supported, Y: Only YCbCr 4:2:0 supported, N: Not supported

Supported resolution	Set value [*]																												
	(#)/Resolution	640 x 480	800 x 600	1024 x 768	1280 x 720 [HDTV]	1280 x 720 [VESA]	1280 x 768	1280 x 800	1280 x 960	1280 x 1024	1360 x 768	1366 x 768	1400 x 1050	1440 x 900	1600 x 900	1600 x 1200	1680 x 1050	1920 x 1080i [HDTV]	1920 x 1080p [HDTV]	1920 x 1080	1920 x 1200	2048 x 1152	2560 x 1440	2560 x 1600	4K@30 (3840 x 2160)	4K@30 (4096 x 2160)	4K@60 (3840 x 2160)	4K@60 (4096 x 2160)	
0 1920 x 1080p [HDTV]	S	S	S	S	N	N	S	S	S	N	S	S	S	S	S	S	S	S	S	N	N	N	N	N	N	N	N	N	N
1 1920 x 1080i [HDTV]	S	S	S	S	N	N	N	N	N	N	N	N	N	N	N	N	N	S	N	N	N	N	N	N	N	N	N	N	N
2 1920 x 1080	S	S	S	S	N	N	S	S	S	N	S	S	S	S	S	S	S	S	S	S	N	N	N	N	N	N	N	N	N
3 1920 x 1200	S	S	S	S	N	N	S	S	S	N	N	S	S	S	S	S	S	S	S	N	S	N	N	N	N	N	N	N	N
4 2048 x 1152	S	S	S	S	N	N	N	N	S	N	N	S	S	S	S	S	S	S	S	N	S	S	N	N	N	N	N	N	N
5 2560 x 1440	S	S	S	N	N	N	N	N	N	S	N	N	S	S	S	S	S	S	S	S	S	S	S	S	N	N	N	N	N
6 2560 x 1600	S	S	S	N	N	N	N	N	N	N	N	S	S	S	S	S	S	S	S	S	S	S	S	S	S	N	N	N	N
7 3840 x 2160 [30]	S	S	S	N	N	N	N	N	N	N	N	S	S	S	S	S	S	S	S	S	S	S	S	N	S	S	N	N	N
8 3840 x 2160 [60 4:2:0]	S	S	S	N	N	N	N	N	N	N	N	S	S	S	S	S	S	S	S	S	S	S	S	N	N	S	N	Y	N
9 3840 x 2160 [60 4:4:4]	S	S	S	N	N	N	N	N	N	N	N	S	S	S	S	S	S	S	S	S	S	S	N	N	S	N	S	N	N
A 4096 x 2160 [30]	S	S	S	N	N	N	N	N	N	N	N	S	S	S	S	S	S	S	S	S	S	S	N	S	S	S	N	N	N
B 4096 x 2160 [60 4:2:0]	S	S	S	N	N	N	N	N	N	N	N	S	S	S	S	S	S	S	S	S	S	S	N	N	S	S	Y	Y	Y
C 4096 x 2160 [60 4:4:4]	S	S	S	N	N	N	N	N	N	N	N	S	S	S	S	S	S	S	S	S	S	S	N	N	S	S	S	S	S

^{*}Set value: Rotary switch Position

[Table 7.3] Supported resolution of Built-in EDID (GROUP 2)

S: Supported, Y: Only YCbCr 4:2:0 supported, N: Not supported

Supported resolution	Set value* (#)/Resolution	640 x 480	800 x 600	1024 x 768	1280 x 720 [HDTV]	1280 x 720	1280 x 768	1280 x 800	1280 x 960	1280 x 1024	1360 x 768	1366 x 768	1400 x 1050	1440 x 900	1600 x 900	1600 x 1200	1680 x 1050	1920 x 1080i [HDTV]	1920 x 1080p [HDTV]	1920 x 1080	1920 x 1200	2048 x 1152	2560 x 1440	2560 x 1600	4K@30 (3840 x 2160)	4K@30 (4096 x 2160)	4K@60 (3840 x 2160)	4K@60 (4096 x 2160)
		0	1024 x 768	S	S	S	N	N	N	N	N	N	N	N	N	N	N	N	N	N	N	N	N	N	N	N	N	N
1	1280 x 720 [HDTV]	S	S	S	S	N	N	N	N	N	N	N	N	N	N	N	N	N	N	N	N	N	N	N	N	N	N	N
2	1280 x 720 [VESA]	S	S	S	N	S	N	N	N	N	N	N	N	N	N	N	N	N	N	N	N	N	N	N	N	N	N	N
3	1280 x 768	S	S	S	S	N	S	N	N	N	N	N	N	N	N	N	N	N	N	N	N	N	N	N	N	N	N	N
4	1280 x 800	S	S	S	S	N	S	S	N	N	N	N	N	N	N	N	N	N	N	N	N	N	N	N	N	N	N	N
5	1280 x 960	S	S	S	S	N	S	S	S	N	N	N	N	N	N	N	N	N	N	N	N	N	N	N	N	N	N	N
6	1280 x 1024	S	S	S	S	N	S	S	S	S	N	N	N	N	N	N	N	N	N	N	N	N	N	N	N	N	N	N
7	1360 x 768	S	S	S	S	N	S	S	S	S	N	S	N	N	N	N	N	N	N	N	N	N	N	N	N	N	N	N
8	1366 x 768	S	S	S	S	N	S	S	S	S	N	S	N	N	N	N	N	N	N	N	N	N	N	N	N	N	N	N
9	1400 x 1050	S	S	S	S	N	N	S	S	S	N	S	S	N	N	N	N	N	N	N	N	N	N	N	N	N	N	N
A	1440 x 900	S	S	S	S	N	N	S	S	S	N	S	S	S	N	N	N	N	N	N	N	N	N	N	N	N	N	N
B	1600 x 900	S	S	S	S	N	N	S	S	S	N	S	S	S	S	N	N	N	N	N	N	N	N	N	N	N	N	N
C	1600 x 1200	S	S	S	S	N	N	S	S	S	N	S	S	S	S	S	N	N	N	N	N	N	N	N	N	N	N	N
D	1680 x 1050	S	S	S	S	N	N	S	S	S	N	S	S	S	S	S	S	N	N	N	N	N	N	N	N	N	N	N

*Set value: Rotary switch Position

7.1.2 Selecting Built-in EDID

Follow the procedure below to output video and audio from a source device using the Built-in EDID.

1. Connect a source device and monitor to the DDC-03UHD-A.

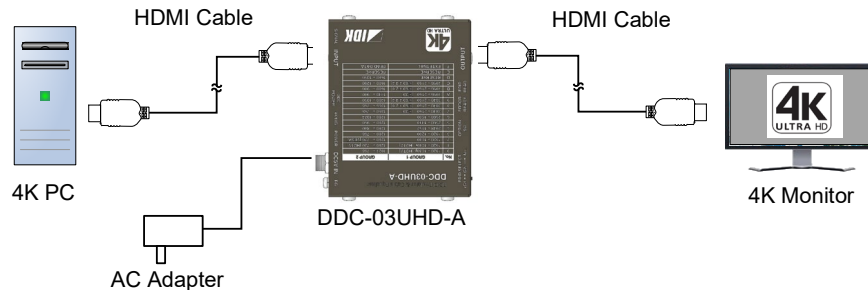

[Fig. 7.2] Connecting PC and Monitor

2. Power on the DDC-03UHD-A, source device, and monitor.

The Power LED, DDC POWER LED, and SIGNAL LED illuminate green.

If HDMI signal of 18 Gbps that is sent from the source device is input to the DDC-03UHD-A, the 4K18G LED illuminates green.

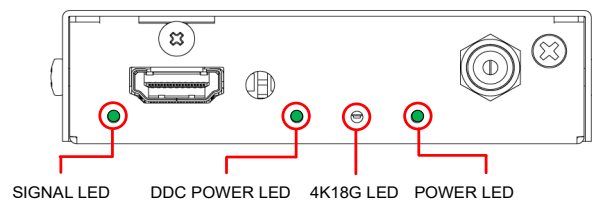

[Fig. 7.3] LEDs when Powered ON

3. Select the desired group (G1 or G2) of the Built-in EDID using the EDID slide switch, and then select the desired EDID number of the Built-in EDID using the EDID rotary switch.

The source device starts to read the desired Built-in EDID.

【See: [Fig. 7.1] Grouping EDID】

【See: 7.1.1 Supported Resolution】

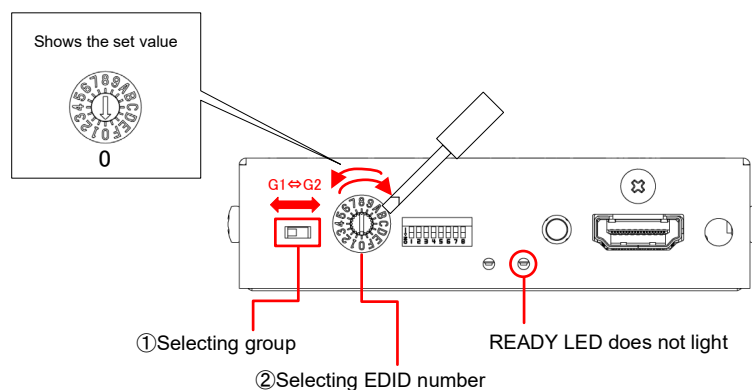

[Fig. 7.4] Selecting Built-in EDID

4. The source device outputs video and audio using the selected Built-in EDID.

7.2 Using Copied EDID

Copied EDID is not registered by factory default.

If there is no copied EDID, the DDC-03UHD-A uses GROUP1 “No.0” EDID (1920 x 1080p [HDTV]) automatically in order to output video and audio.

7.2.1 Setting Copied EDID

Follow the procedure below to copy EDID of the monitor that is connected to the DDC-03UHD-A.

1. Connect the DDC-03UHD-A to a monitor and power on them.

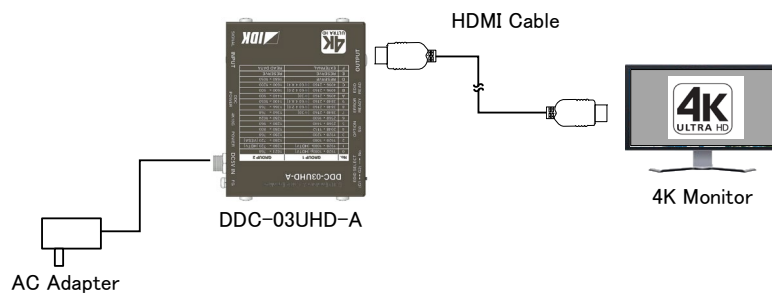

[Fig. 7.5] Connecting DDC-03UHD-A and monitor

2. Set the EDID slide switch to “G2” and set the EDID rotary switch to “F”.

If the EDID is not recorded in the DDC-03UHD-A, the ERROR LED illuminates red.

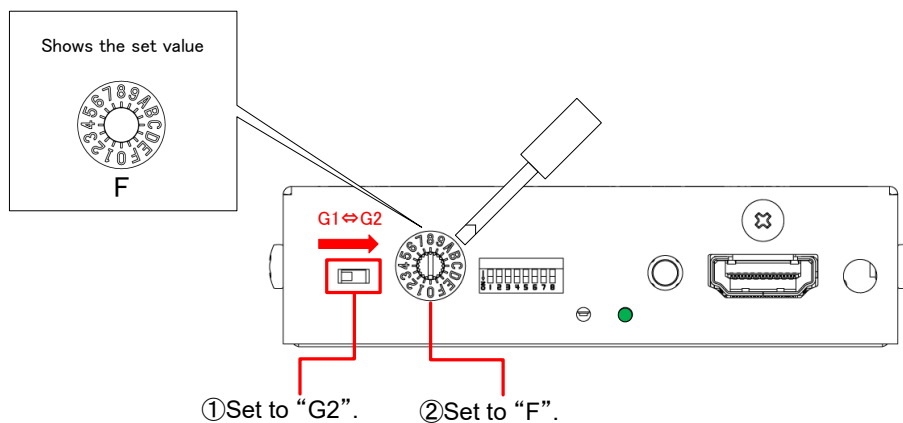

[Fig. 7.6] Setting Copied EDID

- EDID that is copied from monitor is not recorded in the DDC-03UHD-A.

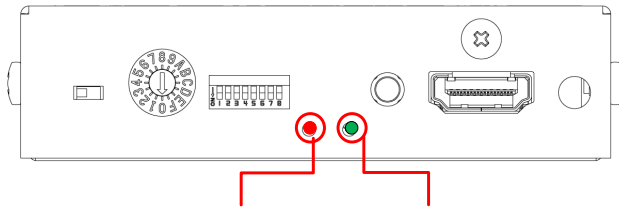

ERROR LED Flashes red READY LED Illuminates green

- Another EDID is already recorded in the DDC-03UHD-A.

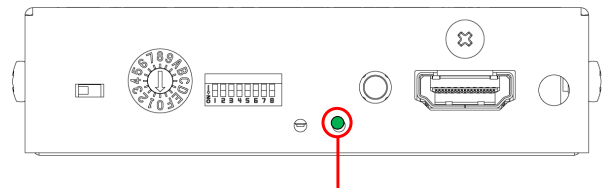

READY LED Illuminates green

[Fig. 7.7] ERROR/READY LEDs

3. After ensuring that the Error LED flashes or does not illuminate, press the EDID READ button using a sharp-ended object (e.g. pencils) to copy the EDID of the monitor.

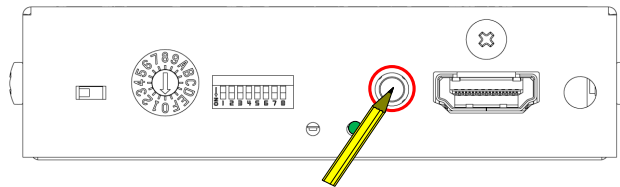

[Fig. 7.8] Copying EDID

Note:

If the rotary switch is set to “0” to “E”, the ERROR LED illuminates red for a second, and the EDID is not copied to the DDC-03UHD-A. Change the setting of the switch to “F” and press the EDID READ button again.

If the EDID cannot be copied for some reasons or if the target EDID has problems, the ERROR LED illuminates red. In such a case, check the cable connection and press the EDID READ button again to retry the copy procedure.

- EDID is being copied correctly

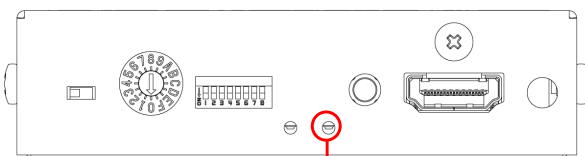

READY does not illuminate

- EDID cannot be copied.

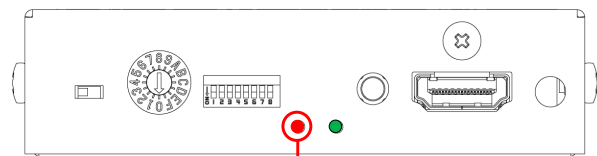

ERROR illuminates red

[Fig. 7.9] READY/ERROR LED while EDID is being copied

4. When EDID copy is completed, the READY LED illuminates green.

The DDC-03UHD-A records only one EDID.

If another EDID is recorded in the DDC-03UHD-A, the old EDID will be overwritten.

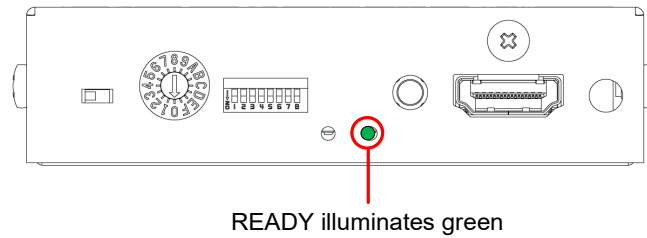

[Fig. 7.10] EDID copy is completed

7.2.2 Outputting video and audio using Copied EDID

Follow the procedure in “7.1.2 Selecting Built-in EDID” to output video and audio from a source device using Copied EDID. Use “GROUP2” and “No. F” for the EDID.

【See: 7.1.2 Selecting Built-in EDID】

7.2.3 Deleting Copied EDID

Follow the procedure below to delete the Copied EDID.

Once the Copied EDID is deleted, the External EDID will also be deleted.

【See: 7.3 Using External EDID】

1. While pressing the EDID READ button, power on the DDC-03UHD-A.

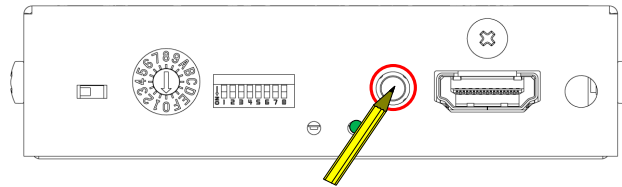

[Fig. 7.11] EDID READ button

2. While the EDID is being deleted, the ERROR LED illuminates red.

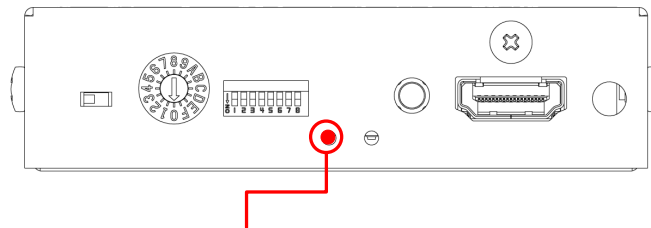

ERROR illuminates red

[Fig. 7.12] Deleting copied EDID

3. EDID copy is completed.

● READ DATA is selected

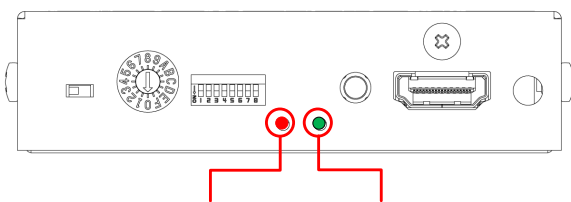

ERROR flashes red READY illuminates green

● Other EDID is selected

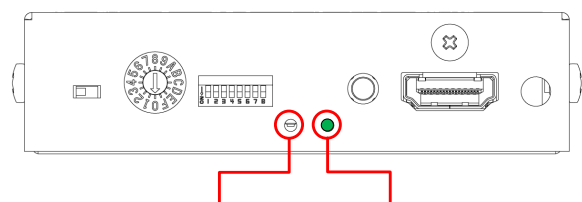

ERROR does not illuminate READY illuminates green

[Fig. 7.13] EDID deletion is completed

Tip:

Once EDID is deleted, Copied EDID and External EDID that are recorded in the DDC-03UHD-A will also be deleted.

If the EDID setting is set to Copied EDID (READ DATA) and any copied EDID is not recorded in the DDC-03UHD-A; the ERROR LED flashes red. In such a case, the EDID is set to "GROUP1"s "No.0" (1920 x 1080p [HDTV]).

7.3 Using External EDID

External EDID is not registered by factory default. Follow the procedure in “7.3.1 Setting External EDID” to use External EDID. Once EDID is registered, the EDID is recorded in the DDC-03UHD-A.

When the monitor is changed with another one, the new monitor’s EDID will be acquired and the EDID in the DDC-03UHD-A will be overwritten in the following case: the DDC-03UHD-A is set to “EXTERNAL” (External EDID) and video signal is input to the DDC-03UHD-A.

Follow the procedure below to output video and audio from a source device using the Built-in EDID.

If you need to delete External EDID that is recorded in the DDC-03UHD-A, follow the procedure in “7.2.3 Deleting Copied EDID”. Once it is completed, External EDID and Copied EDID will be deleted from the DDC-03UHD-A.

7.3.1 Setting External EDID

Follow the procedure below to output video and audio from a source device using the External EDID.

1. Connect a source device and monitor to the DDC-03UHD-A and power on them.

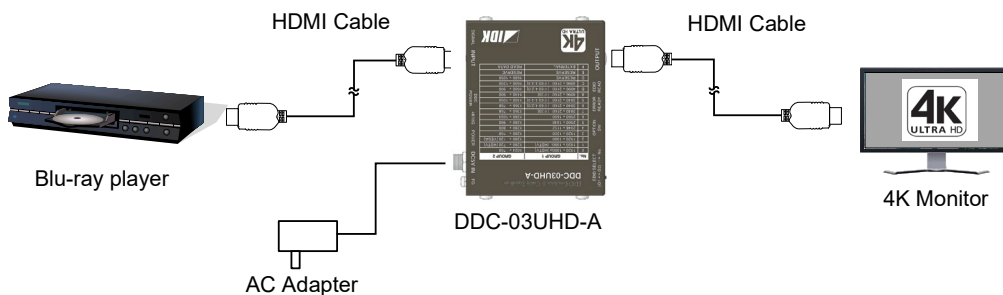

[Fig. 7.14] DDC-03UHD-A is connected to a Blu-ray player and monitor

2. Set the EDID slide switch to “G1” and set the EDID rotary switch to “F”.

The EDID of the monitor that is connected to the DDC-03UHD-A will be recorded in the DDC-03UHD-A.

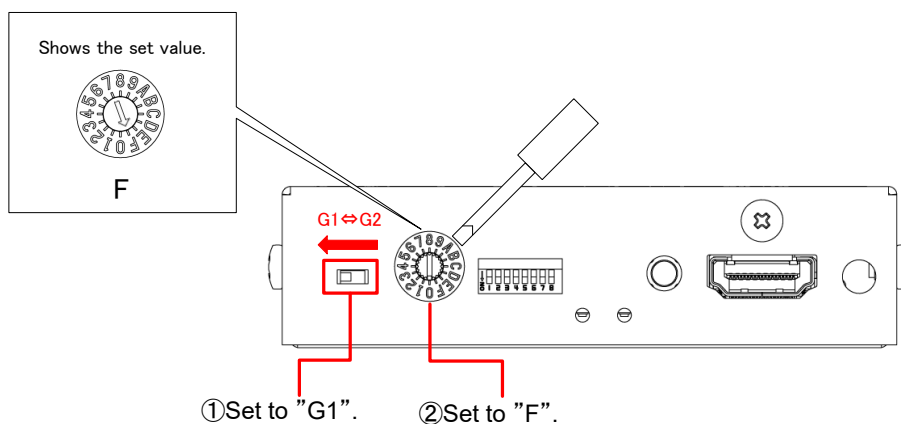

[Fig. 7.15] Setting External EDID

If the EDID cannot be acquired for some reasons or if the acquired EDID has problems, the ERROR LED illuminates red.

● EDID is acquired correctly.

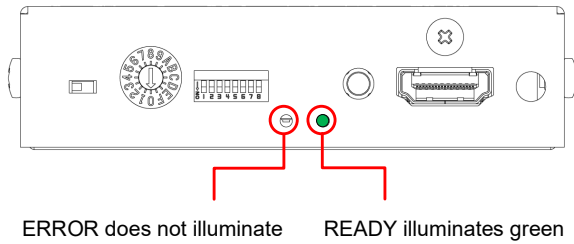

● EDID cannot be acquired.
External EDID id set, but EDID cannot be acquired.

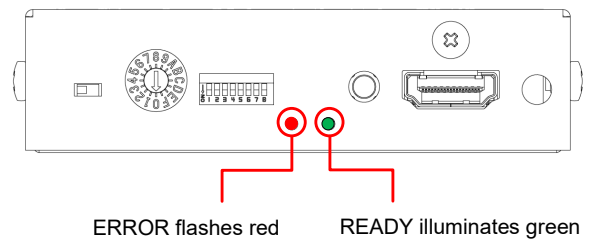

● EDID cannot be acquired.
The acquired EDID has problems.

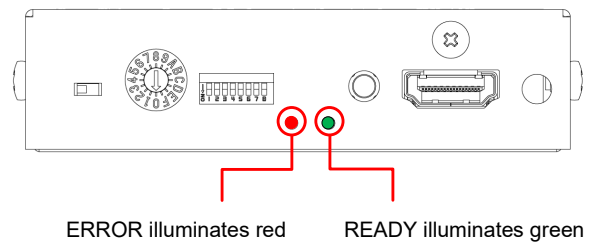

● EDID is acquired correctly.

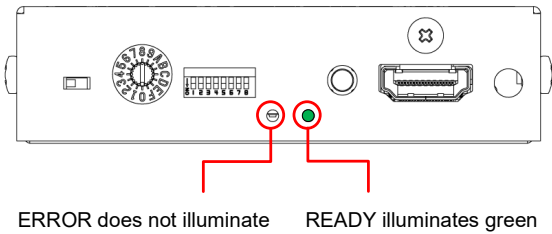

● EDID cannot be acquired.
External EDID is set, but EDID cannot be acquired.

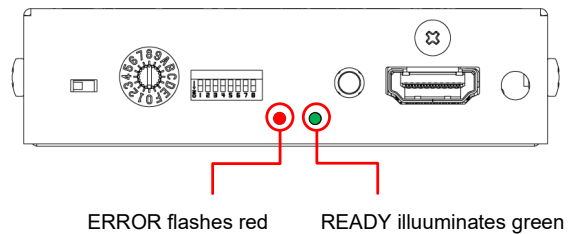

● EDID cannot be acquired.
The acquired EDID has problems.

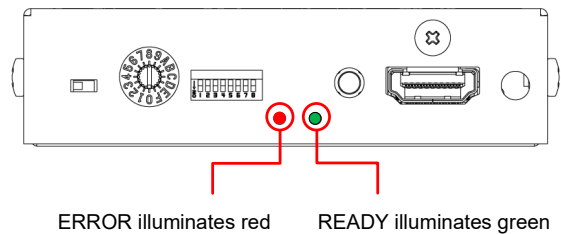

[Fig. 7.16] Acquiring EDID

3. The source device outputs video and audio using the EDID of the connected monitor.

8 DIP Switch

The DIP switch enables/disables equalizer, audio input enabled/disabled, HDCP input enabled/disabled, and Non-signal input monitoring.

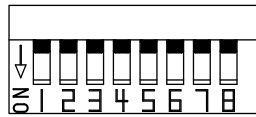

[Fig. 8.1] DIP Switch

[Table 8.1] DIP switch setting by default

SW	Function	Default	SW default setting	Page
1	Input Equalizer	Automatic/Manual	Automatic	30
2		Correction	None	
3			OFF	
4	Output equalizer	Disabled	OFF	31
5	Audio input Enabled/Disabled	Enabled	OFF	31
6	HDCP input Enabled/Disabled	Enabled	OFF	32
7	No-signal input monitoring	15 sec.	OFF	33
8			OFF	

8.1 Input Equalizer

The amount of signal correction is corrected automatically depending on the deterioration of input signal by setting the DIP switch “1” to “OFF”. However, with some source devices, the amount of the correction may not be corrected automatically. In such a case, set the amount of correction manually depending on the cable length.

[Table 8.2] Amount of Cable correction

Correction amount	SW1	SW2	SW3
Automatic*	OFF	N/A	N/A
None	ON	OFF	OFF
Low	ON	ON	OFF
Middle	ON	OFF	ON
High	ON	ON	ON

*Default: Automatic

8.2 Output equalizer

If video is still interrupted even with the input equalizer enabled, enable the output equalizer.

【See: 8.1 Input Equalizer】

[Table 8.3] Cable equalization

Enabled/Disabled	SW4
Disabled*	OFF
Enabled	ON

*Default: Disabled

8.3 Audio input Enabled/Disabled

This function controls audio output of source device using the audio information of Built-in EDID.

Only Built-in EDID of GROUP 1's No.0 to No.6 and GROUP 2's No.0 to No.D are supported.

Audio information is registered in the Built-in EDID. If you do not want to output audio from a source device, set DIP switch5 to "ON". When the DIP switch is operated, the source device acquires the Built-in EDID and outputs audio according to the EDID.

[Table 8.4] Audio setting

Audio format	Sampling frequency (kHz)	Number of speakers	Speaker configuration	SW5
Linear PCM*	32/44.1/48	2	FR/FL	OFF
None	None	None	None	ON

Default: Linear PCM

Note:

If an HDCP 2.2-supported source device and monitor are connected and the audio input function of the DDC-03UHD-A is disabled, signal that is not in line with the specification may be output and it may cause snowy video.

8.4 HDCP input Enabled/Disabled

Some source devices check whether the connected monitor supports HDCP. Since the DDC-03UHD-A is HDCP compliant, video signal with HDCP will be output when a non-HDCP-compliant monitor is connected. As the result, the video may not be displayed. In these cases, the problem can be solved by disabling PC's HDCP output.

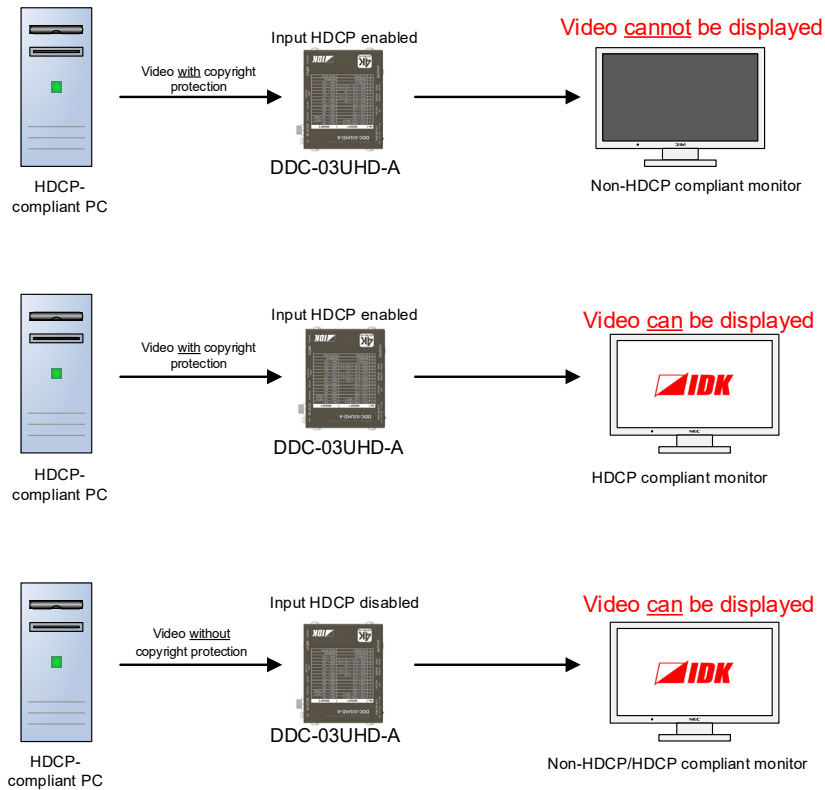

[Fig. 8.2] HDCP input

[Table 8.5] HDCP input setting

HDCP input	SW6
Enabled*	OFF
Disabled	ON

Default: Enabled

Notes:

- HDCP2.2 (stream type 0) contents can be displayed on HDCP1.4-compliant monitor.
- HDCP2.2 (stream type 1) contents can be displayed on HDCP2.2-compliant monitor but cannot be displayed on HDCP1.4-compliant monitor.
- The version of HDCP cannot be set.

8.5 No-signal input monitoring

If you change the settings of EDID or power off/on the DDC-03UHD-A, the source device may not output video signal. Use this function to set the monitoring time which is from when a source device stops outputting signal to when the DDC requests the source device to output video signal.

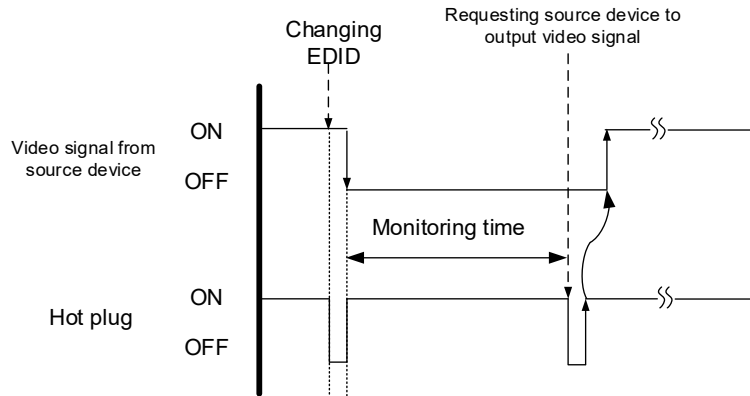

[Fig. 8.3] Monitoring time

[Table 8.6] Setting monitoring time

Monitoring time	SW7	SW8
15 seconds	OFF	OFF
30 seconds	ON	OFF
7 seconds	OFF	ON
Does not monitor	ON	ON

Default: 15 seconds

Notes:

- If you use the monitor power-saving function or Dual monitor function of the PC, set this menu to "OFF". The PC that receives output request may cancel those functions.
- If you set shorter time than the time which the source device outputs video, the source device may not output video. In such a case, change the setting to longer time.

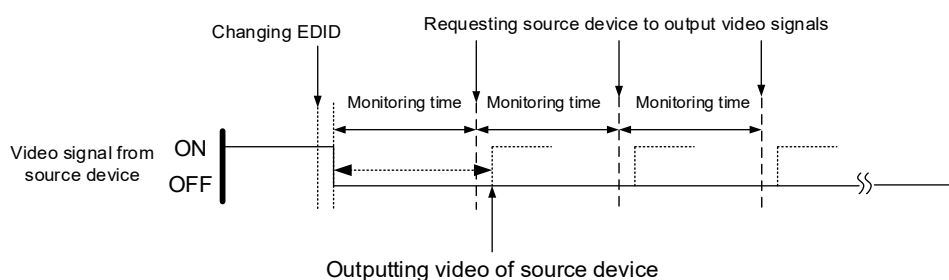

[Fig. 8.4] Repeating reset

10 Troubleshooting

In case the DDC-03UHD-A does not work correctly, please check the following items first. Also refer to manuals for connected devices as well, since they may possibly be the cause of the problem.

- Are the DDC-03UHD-A and all connected devices powered on correctly?
- Are signal cables connected correctly?
- Are there any loose or partially mated connections?
- Are the interconnecting cables specified correctly to support adequate bandwidth?
- Are specifications of connected devices matched to each other?
- Are configuration settings for the connected devices correct?
- Is there any nearby equipment that may cause electrical noise/RF interference??

If the problem still cannot be solved, please check needed items.

Problem	Cause/Check item/Solution	Page
● Video output		
Video is not output	[1] Does the DDC POWER LED illuminate? If not, ensure that a monitor is connected to the DDC-03UHD-A and powered on.	—
	[2] Check the HDCP of the digital input video. Some source devices check whether the sink device is HDCP compliant or not and they output video depending on the result. Because the DDC-03UHD-A supports HDCP, video cannot be displayed if a non-HDCP compliant monitor is connected. In such a case, disable HDCP input in “8.4 HDCP input Enabled/Disabled” .	32
	[3] The set time for monitoring no-signal input may be too short. Change the setting to longer time. If you set shorter time than the time which the source device outputs video, the source device may not output video. In such a case, change the setting to longer time.	33
	[4] Is the selected Built-in EDID supported by the monitor? • If Built-in EDID is set to “1920 x 1080i”, video may not be output to monitors that do not support interlace signal. • While some monitors for PC does not support HDTV resolutions, some LC TVs and plasma TVs do not support VESA resolutions (XGA to WSXGA+).	19
	[5] Is a resolution that is not supported by the connected monitor input? Check the resolution and video frequency and refer to the monitor’s specification.	—
	[6] If the source device has multiple output connectors, check the video output settings of the source device.	

Problem	Cause/Check item/Solution	Page
Video is not displayed. Video is interrupted. Noise is on video.	[7] If using a long cable for input or output, replace it with a 5 m/16.4 ft. or shorter cable. Since the DDC-03UHD-A has the equalizing function, long cables can be connected, but the DDC-03UHD-A may not provide its full performance for some cases (depending on the cable quality and the connected device). If the problem is solved by replacing the cable, signal may have been degraded due to the long haul transmission. In such a case, enable the equalizer and set the amount of cable correction.	30 31
	[8] When high-speed signal (high resolution: such as UXGA, WUXGA, QWXGA, WQHD, WQXGA, 1080p, 4K; DEEP COLOR signal) is input and output, video may not be displayed or noise may appear depending on the cable quality and the connected device. In such a case, change the resolution and/or the color depth of Deep Color.	—
Video flickers	If interlace signal is input to a sink device that does not support interlace signal, the video may flicker. Check the output resolution of the sink device.	—
The left, right, top and bottom sides are cut off.	Some monitors display input video with overscan, and then the video may be cut off. Check the display setting of the monitor.	—
Video is reduced vertically or horizontally.	Some monitors display input video in full-screen, and then the aspect ratio may not be kept. Check the display setting of the monitor. If the full-screen display cannot be disabled, change the output resolution of the source device.	—
Black is displayed at top, bottom, right and left on PC video or only part of the PC video is displayed, and the rest is displayed by scrolling with the mouse.	Does the PC resolution (you can check it in “Properties” of the PC) match the resolution that is output from the PC? If not, set the EDID and PC resolution. If the copy of the built-in LCD screen is output in the laptop, the output to an output monitor is limited to the resolution of the LCD screen. As a result, black may be displayed at edges. The problem can be solved by enlarging the display or displaying only to the external monitor.	—
PC’s dual monitor cannot be set or the setting is canceled.	If the monitoring function for no-signal input works, the dual monitor function may not work correctly. In this case, set “ 8.5 No-signal input monitoring ” to “OFF”.	33

Problem	Cause/Check item/Solution	Page
● Audio output		
Audio is not output.	Check the setting of “ 8.3 Audio input Enabled/Disabled ”. Set SW5 to “OFF”.	31
	If there are multiple output connectors in the source device, check the audio output setting.	—
	Is video output correctly? If not, check [1] to [8].	—
	Is DVI signal output from the source device? DVI signal may be output depending on Built-in EDID settings. If 4K's EDID is set, DVI signal may be output with a source device that does not supports 4K.	31
	Is the input audio format supported by the connected sink device or AV amplifier input? LCD monitors, especially, may not output 88.2 kHz or higher sampling frequency of linear PCM and compressed audio (such as Dolby Digital, DTS, and so on).	—
● Others		
Devices cannot be controlled through CEC.	Are HDMI cables supporting CEC being used?	—
	To use CEC, enable HDMI link control of the connected devices (such as LCD TVs, Blu-ray recorder, and so on).	—

If additional assistance is required, please perform the following tests and then contact us.

No.	Checking items	Result
1	The problem occurs at all connectors?	Yes or No
2	Connect the devices using genuine cables without connecting the DDC-03UHD-A. The problem still cannot be solved? Please contact us for assistance.	Yes or No

User Guide of DDC-03UHD-A

Ver.1.1.0

Issued on: 4 March 2020



Headquarters IDK Corporation
7-9-1 Chuo, Yamato-shi, Kanagawa-pref.
242-0021 JAPAN
TEL: +81-46-200-0764 FAX: +81-46-200-0765
Email: idx_eng@idx.co.jp URL: <http://www.idxkav.com>

USA IDK America Inc.
72 Grays Bridge Road Suite 1-C, Brookfield, CT 06804
TEL: +1-203-204-2445
Email: sales@idxkav.com URL: <http://www.idxkav.com>

Europe IDK Europe GmbH
Lise-Meitner-Str. 6, D-40878 Ratingen
TEL: +49-2102-578-301-0
Email: info@idxkav.eu URL: <http://www.idxkav.com>



**Product information
Support** Arvanics Corporation
7-9-1 Chuo, Yamato-shi, Kanagawa-pref.
242-0021 JAPAN
TEL: +81-46-259-6920 FAX: +81-46-259-6930
Email: info@arvanics.com URL: <http://www.arvanics.com>

Information in this document is subject to change without notice.
All rights reserved. All trademarks mentioned are the property of their respective owners.