



Video Conference Camera

User Manual

DV01K

V 1.1

Copyright and disclaimer

Disclaimer

BenQ Corporation makes no representations or warranties, either expressed or implied, with respect to the contents of this document. BenQ Corporation reserves the right to revise this publication and to make changes from time to time in the contents thereof without obligation to notify any person of such revision or changes.

Copyright

Copyright 2024 BenQ Corporation. All rights reserved. No part of this publication may be reproduced, transmitted, transcribed, stored in a retrieval system or translated into any language or computer language, in any form or by any means, electronic, mechanical, magnetic, optical, chemical, manual or otherwise, without the prior written permission of BenQ Corporation.

Product support

This document aims to provide the most updated and accurate information to customers, and thus all contents may be modified from time to time without prior notice. Please visit the website for the latest version of this document and other product information. Available files vary by model.

- Make sure your computer is connected to the Internet.
- Visit the local website from www.BenQ.com. The website layout and content may vary by region/country.
- User manual and related document: www.BenQ.com > Business > SUPPORT > Downloads > model name > User Manual
- (EU only) Dismantled information: Available on the user manual download page. This document is provided based on Regulation (EU) 2019/2021 to repair or recycle your product. Always contact the local customer service for servicing within the warranty period. If you wish to repair an out-of-warranty product, you are recommended to go to a qualified service personnel and obtain repair parts from BenQ to ensure compatibility. Do not disassemble the product unless you are aware of the consequences. If you cannot find the dismantled information on your product, contact the local customer service for assistance.

Table of contents

Copyright and disclaimer	i
Product support	ii
Important notices	1
Package contents	2
Installation instructions	2
Product interface	2
Install camera	3
Use the privacy cover	3
Camera settings	4
Settings	5
Enhance your video conferencing experience with Camera framing	5
Enable Voice tracking in your conferencing apps	6
Update firmware	7
Product information	9
Specifications	9
Dimensions	10
Maintenance	11
Troubleshooting	11

Important notices

This manual briefly introduces the camera functions, installation, and operations. Please read carefully before application.

Application instructions

To prevent damages to this camera or any products connected to it, this product can only be used within the specified range:

1. Do not expose the camera to rain or moisture.
2. This product contains no parts which can be maintained by users themselves. Any damage caused by dismantling the product by user without permission is not covered by warranty.
3. To prevent an electric shock, do not disassemble the camera; only qualified technicians can perform installation and maintenance.
4. Do not use under conditions that exceed the limited temperature, humidity or power supply specifications.
5. When cleaning the camera lens, please wipe it with a dry soft cloth. When the product is heavily soiled, please wipe it gently with a neutral detergent. Do not use strong or corrosive cleaning agents to avoid scratching the lens and affecting the image quality.

Electric safety

This product must be installed in strict compliance with local electrical safety standards.

Transport caution

Avoid heavy pressure, severe vibration, soaking damage to the product in transportation, storage, and installation.

Careful installation

1. The camera body is made of organic material, please do keep away from corrosive liquid, gas, or solid material.
2. Do not rotate the camera head violently, otherwise it may cause mechanical failure;
3. This product should be placed on a stable desktop or other horizontal surface. Do install the product obliquely, otherwise it may display inclined image.
4. Ensure there are no obstacles within rotation range of the holder.
5. Do not power on before completing installation.

Do not disassemble discretionarily

We are not responsible for any damage caused by unauthorized disassembling.

Package contents

Open the sales package and check the contents. If any item is missing or damaged, please contact your dealer immediately.

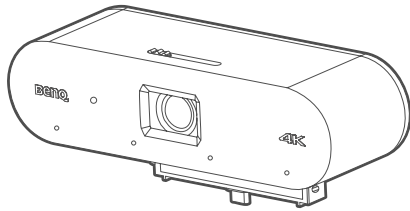

4K UHD Camera

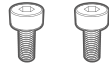

Screw x 2

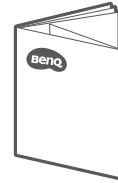

User documents (quick start guide, regulatory sheets)



- Before discarding the package, check that you haven't left any accessories inside the box.
- Do not leave plastic bags within reach of young children or babies.

Installation instructions

Product interface

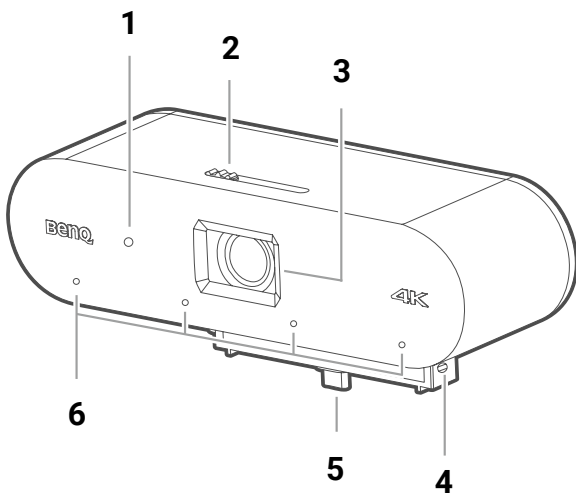

1. Status light

Lights up blue when camera is on.

2. Privacy cover switch

3. Fixed-focus lens

4. Screw hole

5. USB-C connector

6. Omni-directional microphones

Install camera

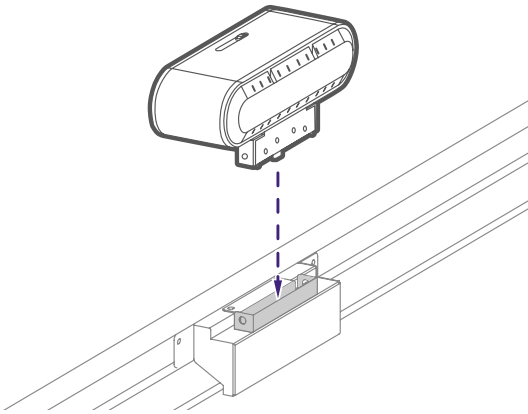

1. Connect your camera to the USB-C port on the top of the display.

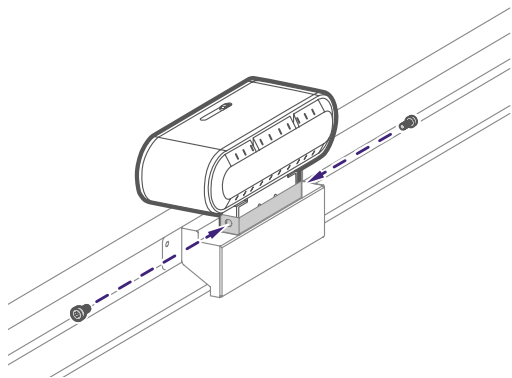

2. Secure the camera with the provided screws.

Use the privacy cover

Slide the privacy cover switch to the right to cover the lens.

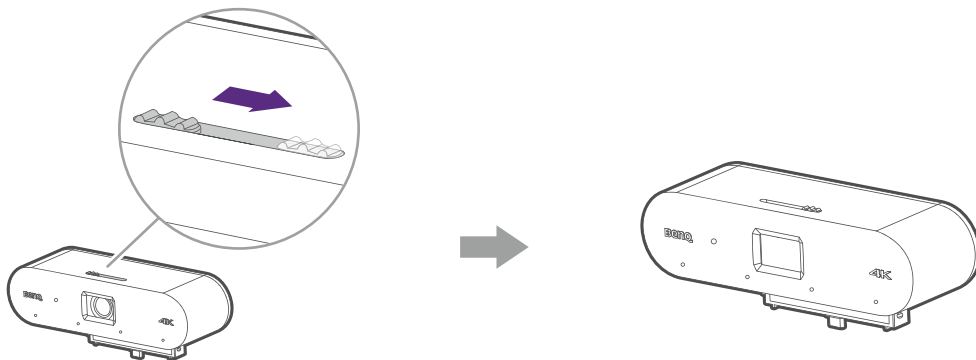

Camera settings



The screenshots in this document are for reference only and may differ from actual design.

To adjust camera settings, select **BenQ Camera**  app in your app list.

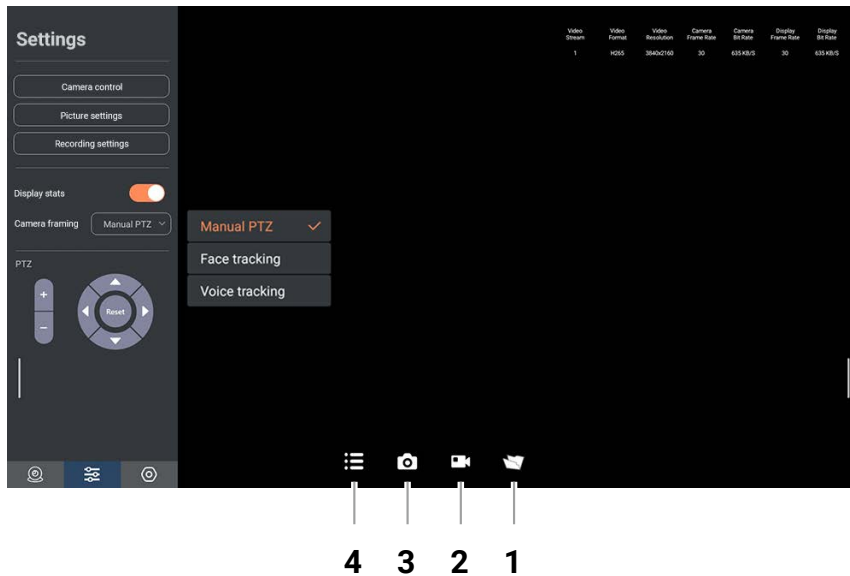

1. File explorer



View the collection of pictures and videos taken.

2. Record

3. Capture

4. Menu

Tap to open the setting column. The setting options are as below.

Icon	Menu	Descriptions
	Device info	View device name and upgrade firmware. See Update firmware on page 7 for details.
	Settings	Adjust camera settings and camera framing. See Settings on page 5 for details.
	Video settings	Adjust camera file format, resolution, frame rate, etc.

Settings

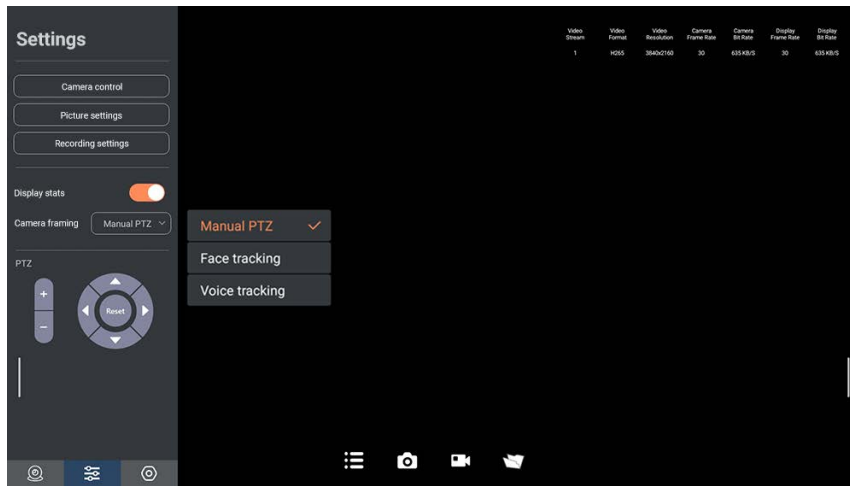

Menu	Descriptions
Camera control	Adjust anti-flicker options, mirror horizontally or vertically.
Picture settings	Adjust brightness, contrast, saturation, sharpness etc.
Recording settings	Set maximum video duration and test the audio quality.
Display stats	Enable the function to display camera specs at the top right corner of the screen.
Camera framing	Adjust the camera framing according to your needs. See Enhance your video conferencing experience with Camera framing on page 5 for details.

Enhance your video conferencing experience with **Camera framing**

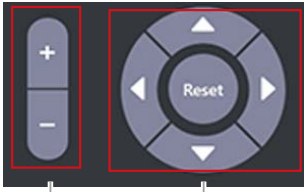

In **BenQ Camera**  app, select **Menu**  > **Settings**  > **Camera framing**. The camera has three framing modes as below:

Menu	Descriptions
Manual PTZ	<p>You can manually adjust the pan, tilt, zoom of the camera.</p>  <ol style="list-style-type: none"> 1. Tap +/- to zoom in and out. 2. Tap direction keys to pan or tilt. Select Reset to restore original framing.

Menu	Descriptions
<p>Face tracking</p>	<p>The camera will automatically track the position of all participants.</p> <p> For access to this camera framing mode as the default setting, update your firmware to the latest version. See Update firmware on page 7 for details.</p>
<p>Voice tracking</p>	<p>The camera will track the position of all participants and automatically focus on the person speaking. See Enable Voice tracking in your conferencing apps on page 6 for details.</p>

Enable **Voice tracking** in your conferencing apps

After properly installed on BenQ Board, the camera automatically enables **Face tracking** when you open a conferencing application. If you'd like the camera framing to automatically focus on the person who is speaking, follow the steps below to enable **Voice tracking**.

1. Open **BenQ Camera**  app in your app list.
2. Select **Menu**  > **Settings** .

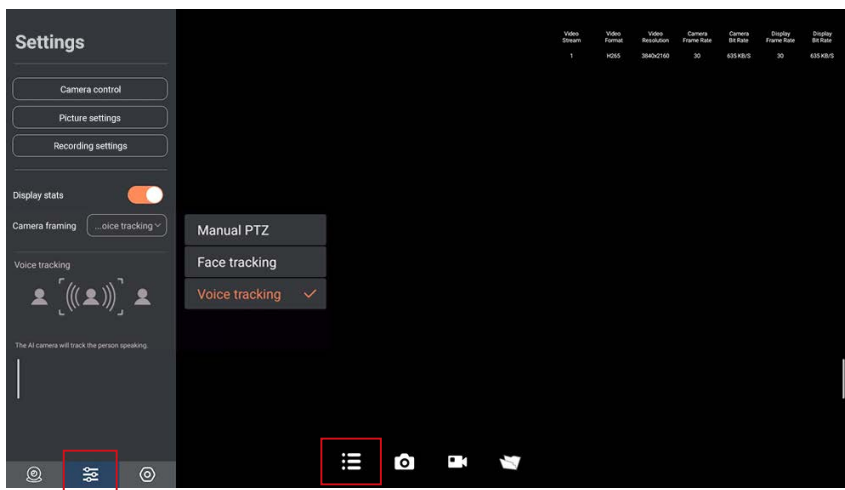

3. Under **Camera framing**, select **Voice tracking**. The changes will be applied directly.

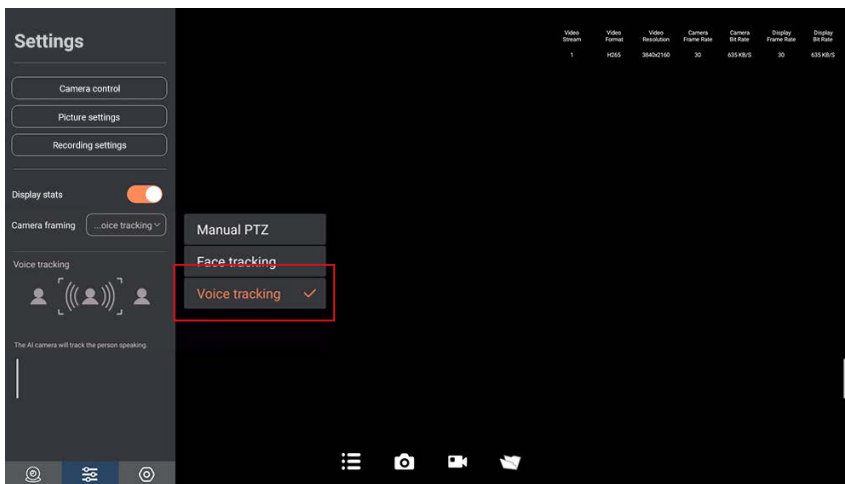

Now when you start your video meeting, the camera will automatically adjust its view to focus on the speaker.

Update firmware

1. In BenQ Board's app list , find **BenQ App Store** .

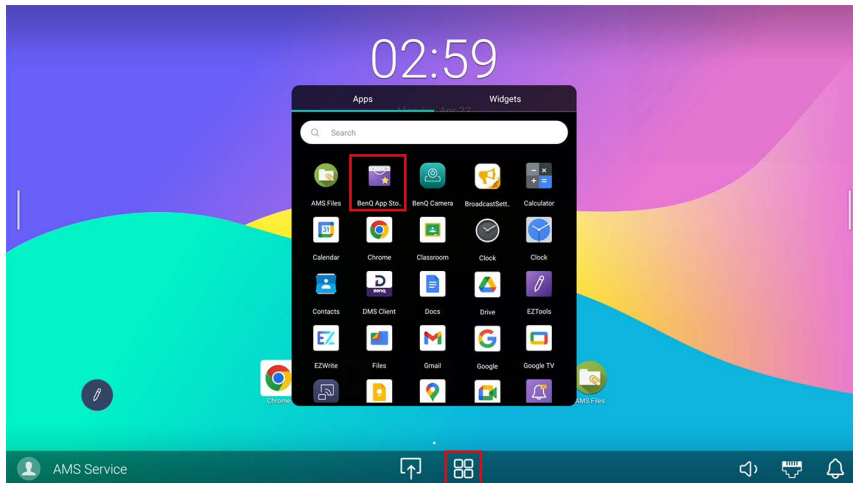

2. Under **BenQ Apps** , select **BenQ Camera**  to download the firmware.

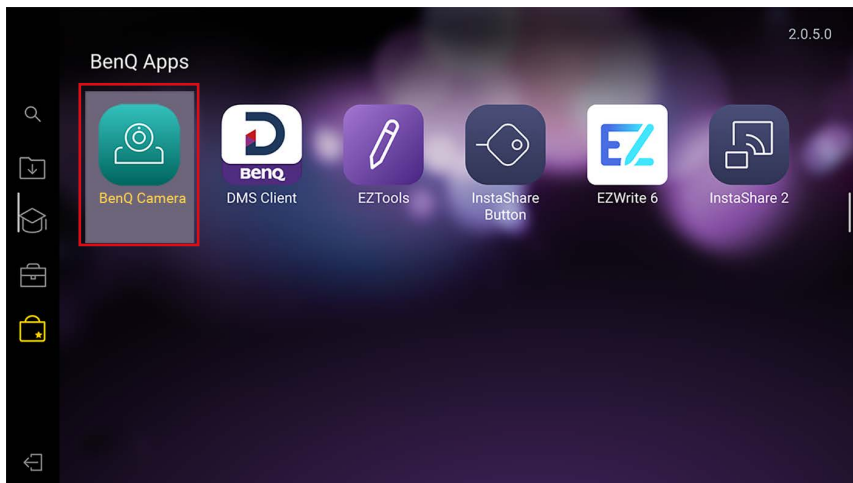

3. In BenQ Board's app list , open **BenQ Camera** .

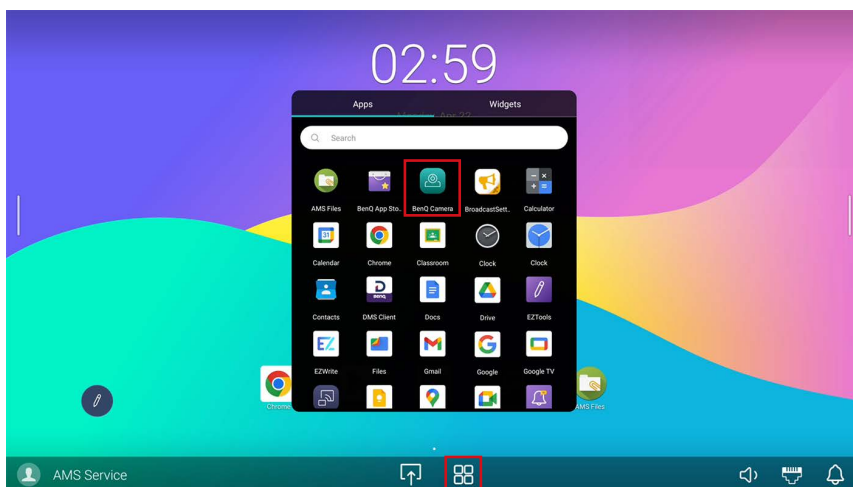

4. Go to **Menu**  > **Device info**  > **Version**. Tap **Update** to start the update.

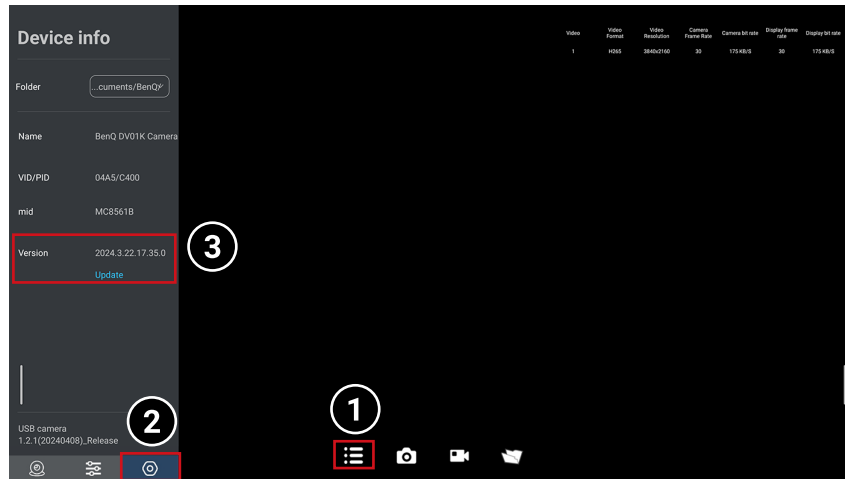

- During the update process, you need to grant access to **BenQ Camera** app. If you see the message below, select **OK**.

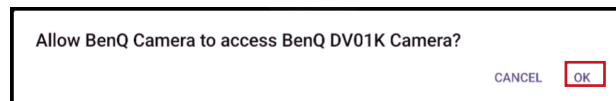

- If the message below pops up, select **Cancel** to continue.

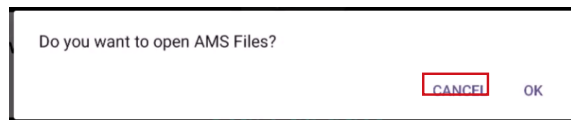

5. Tap **Close** on the screen to finish the update. **BenQ Camera** app will restart.
6. You can check your firmware version in **Device info** (as in step 4).

Product information

Specifications

		Specifications
		DV01K
Camera	Sensor	4K UHD
	Effective Pixels	8.29MP, 16:9
	Field of View	120°(D) / 110°(H) / 70°(V)
	Resolution	4K@30 fps, 1080p@60 fps, 720p@60 fps
	Focus	Fixed
	Lens Type	Glass
	Low Light Performance	0.01 Lux
	Backlight contrast	Auto
	Exposure	Auto
	SNR	>45 dB
Audio & Video	Microphone	Omni-directional mics x 4
	Pickup Range	Up to 8 m
	Output	USB 2.0 Type-C
	Compression Format	MJPEG, YUV2, H.264, H.265
AI Feature	Auto Framing	Yes
	Auto-reframe when participants enter	Yes
	Voice Tracking	Yes
	Noise Reduction	Active noise cancellation (keyboard tapping, knocking, rain, wave, motors and airplane engines sounds)
	AGC (auto gain control)	Yes
Power	Input Voltage	5V
	Input Current	< 1A (max)
	Power Consumption	< 5W (max)
Compatibility	Operating Systems	Windows 7 (1080P/720P), Windows 8.1, Windows 10, Windows 11, macOS™ 10 and higher, Linux (UVC), Chrome™ OS Version 29.0.1547.70 and higher
	USB	Plug and Play
Dimensions	Dimensions (WxHxD)	168.0 x 66.4 x 58.3 mm (6.6 × 2.6 × 2.3 inch)
	Weight	0.30 kg



Specifications and functions are subject to change without notice

Dimensions

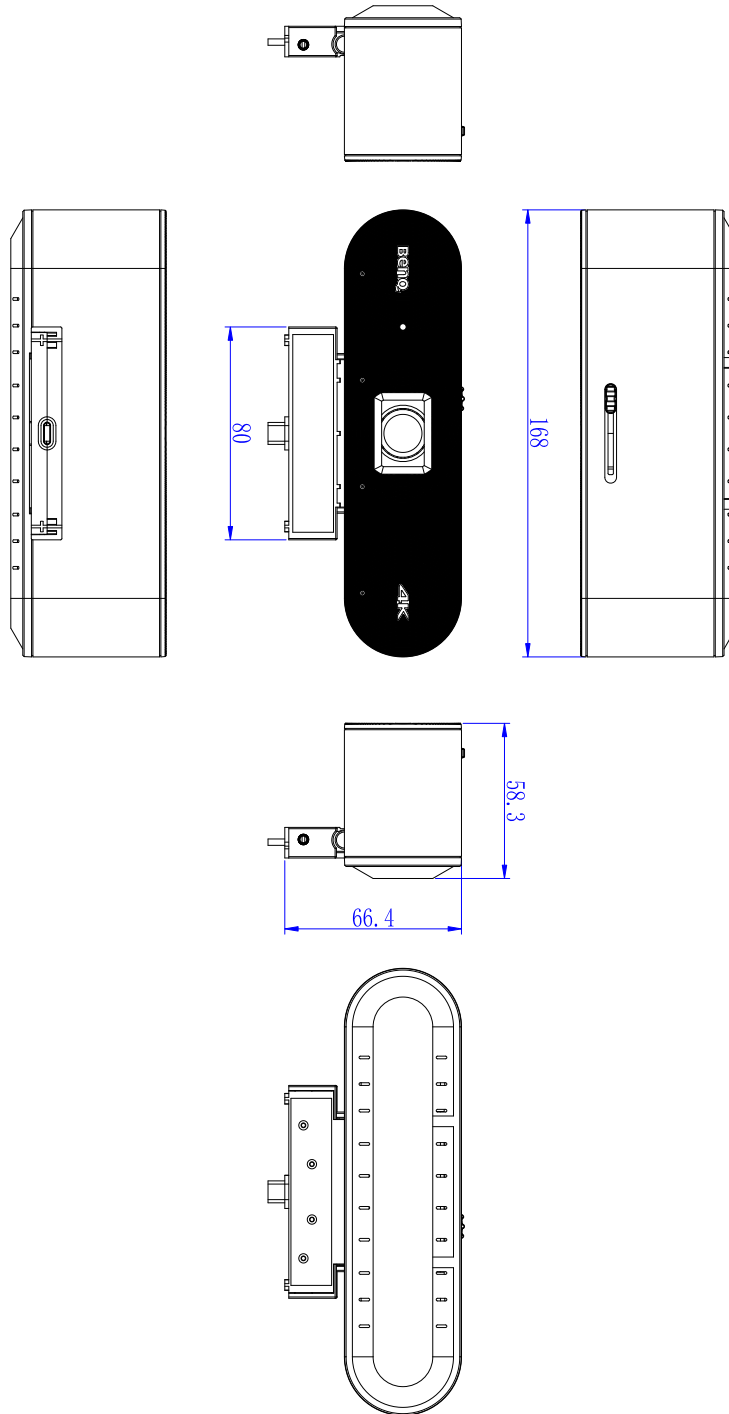

Unit: mm

Maintenance

Clean the lens whenever you notice dirt or dust on the surface.

1. Use soft cloth or tissue to clean the camera cover.
2. Use soft cloth to clean the lens; use neuter cleanser if smeared. Do NOT use strong or corrosive cleanser that may scuff the lens and affect the image.

Troubleshooting

Problem	Solution
No video output & no image	Try methods below: <ul style="list-style-type: none">• Make sure the USB port is normal and the power indication light is on.• Disconnect the camera with computer and re-connect the USB cable.• Check if the video software has selected the right device.
