

UNITS mm [in]		MODEL VAC-S14U	
DRAWN Shibata 2021/03/11	CHECKED Watanabe 2021/03/11	APPROVED Kadowaki 2021/03/11	PART NAME 外観図 DWG No. 114E41
IDK Corporation www.idk.co.jp			REVISION A1
SCALE : 1:2 (A3)			PAGE 1 / 2

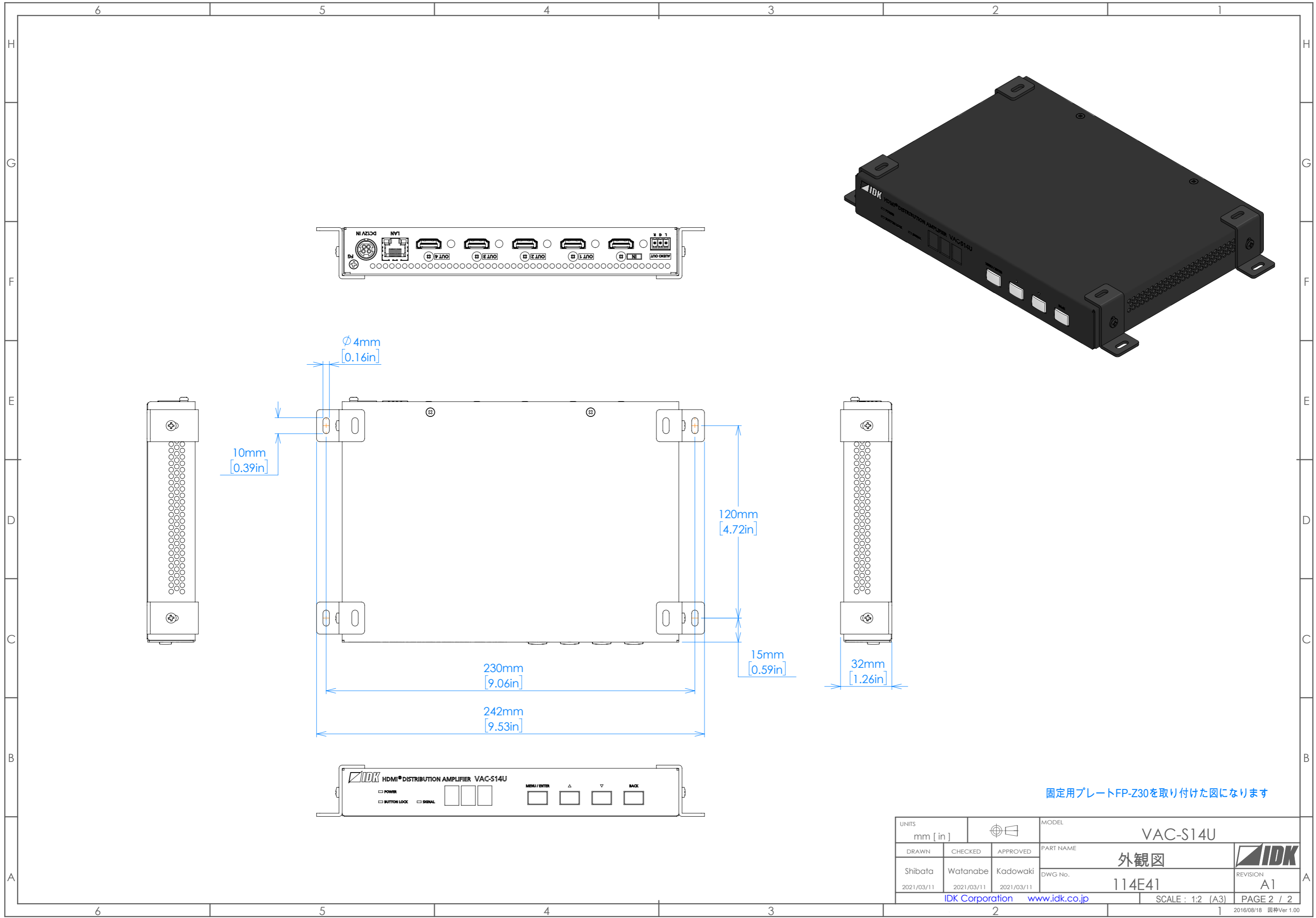

固定用プレートFP-Z30を取り付けた図になります

UNITS mm [in]		MODEL VAC-S14U	
DRAWN Shibata 2021/03/11	CHECKED Watanabe 2021/03/11	APPROVED Kadowaki 2021/03/11	PART NAME 外観図 DWG No. 114E41
IDK Corporation www.idk.co.jp			REVISION A1
SCALE : 1:2 (A3)			PAGE 2 / 2