

Lexicon[®]
by HARMAN



DD-8+ Network Amplifier

Owner's Manual

IMPORTANT SAFETY INSTRUCTIONS

1. Read these instructions.
2. Keep these instructions.
3. Heed all warnings.
4. Follow all instructions.
5. Do not use this apparatus near water.
6. Clean only with a dry cloth.
7. Do not block any ventilation openings. Install in accordance with the manufacturer's instructions.
8. Do not install near any heat sources such as radiators, heat registers, stoves, or other apparatus (including amplifiers) that produce heat.
9. Do not defeat the safety purpose of the polarized or grounding-type plug. A polarized plug has two blades with one wider than the other. A grounding-type plug has two blades and a third grounding prong. The wide blade or the third prong is provided for your safety. If the provided plug does not fit into your outlet, consult an electrician for replacement of the obsolete outlet.
10. Protect the power cord from being walked on or pinched, particularly at plugs, convenience receptacles, and the point where they exit from the apparatus.
11. Only use attachments/accessories specified by the manufacturer.



12. Use only with a cart, stand, tripod, bracket, or table specified by the manufacturer, or sold with the apparatus. When a cart is used, use caution when moving the cart/apparatus combination to avoid injury from tip-over.

13. Unplug this apparatus during lightning storms or when unused for long periods of time.
14. Refer all servicing to qualified service personnel. Servicing is required when the apparatus has been damaged in any way, such as power-supply cord or plug is damaged, liquid has been spilled or objects have fallen into the apparatus, the apparatus has been exposed to rain or moisture, does not operate normally, or has been dropped.
15. Use the mains plug to disconnect the apparatus from the mains.
16. **WARNING:** TO REDUCE THE RISK OF FIRE OR ELECTRIC SHOCK, DO NOT EXPOSE THIS APPARATUS TO RAIN OR MOISTURE.



17. DO NOT EXPOSE THIS EQUIPMENT TO DRIPPING OR SPLASHING AND ENSURE THAT NO OBJECTS FILLED WITH LIQUIDS, SUCH AS VASES, ARE PLACED ON THE EQUIPMENT.

18. THE MAINS PLUG OF THE POWER SUPPLY CORD SHALL REMAIN READILY OPERABLE.



TO PREVENT ELECTRIC SHOCK DO NOT REMOVE TOP OR BOTTOM COVERS. NO USER SERVICEABLE PARTS INSIDE. REFER SERVICING TO QUALIFIED SERVICE PERSONNEL.



TO COMPLETELY DISCONNECT THIS EQUIPMENT FROM THE AC MAINS, DISCONNECT THE POWER SUPPLY CORD PLUG FROM THE AC RECEPTACLE. THE MAINS PLUG OF THE POWER SUPPLY CORD SHALL REMAIN READILY OPERABLE.



WATCH FOR THESE SYMBOLS:



The lightning bolt triangle is used to alert the user to the risk of electric shock.



The exclamation point triangle is used to alert the user to important operating or maintenance instructions.

IMPORTANT



DD-8+ amplifiers require Class 2 output wiring.

MAGNETIC FIELD

CAUTION! Do not locate sensitive high-gain equipment such as preamplifiers or tape decks directly above or below the unit. Because this amplifier has a high power density, it has a strong magnetic field which can induce hum into unshielded devices that are located nearby. The field is strongest just above and below the unit.

If an equipment rack is used, we recommend locating the amplifier(s) in the bottom of the rack and the preamplifier or other sensitive equipment at the top.

CALIFORNIA PROPOSITION 65 WARNING This product contains chemicals known to the State of California to cause cancer and birth defects or other reproductive harm.

DECLARATION OF CONFORMITY

Issued By: Harman International Industries, Incorporated

8500 Balboa Blvd, Northridge,
CA 91329, UNITED STATES

FOR FIELD SERVICE

QUESTIONS CALL: 1 800 691 4171

European Representative's Name and Address:

Harman International Industries Inc.
EMEA Liaison Office, Herikerbergweg 9,
1101 CN Amsterdam, The Netherlands

Equipment Type: Power amplifier **Family Name:** DD Series **Model Names:** DD-8+

EMC Standards:

EN 55013:2013 Sound and television broadcast receivers and associated equipment — Radio disturbance characteristics — Limits and methods of measurement

EN 55020:2007+A11:2011 Sound and television broadcast receivers and associated equipment — Immunity characteristics — Limits and methods of measurement

EN 55022:2010 Information technology equipment — Radio disturbance characteristics — Limits and methods of measurement

EN 55024:2010 Information technology equipment — Immunity characteristics — Limits and methods of measurement

EN 61000-3-2:2006+A1:2008+A2:2009 Limits for Harmonic Current Emissions (equipment input current less than or equal to 16A

EN 61000-3-3:2008 Limitation of Voltage Fluctuations and Flicker in Low-Voltage Supply systems Rated Current less than or equal to 16A

Safety Standard:

EN 60065:2014 Safety Requirements – Audio, Video, and Similar Electronic Apparatus

Eco Design of Energy Standard:

(EC) No 1275/2008 & (EU) No 801/2013 Ecodesign requirements for standby, off mode electric power consumption of electrical and electronic household and office equipment

I certify that the product identified above conforms to the requirements of the EMC Council Directive 2014/30/EU, the Low Voltage Directive 2014/35/EU, the ErP Directive 2012/27/EU and the RoHS Directive 2011/65/EU

Signed 

Todd Eichenbaum
Title: Director of Engineering

Date of Issue: January 1, 2017

Obtaining Other Language Versions:

To obtain information in another language about the use of this product, please contact your local Lexicon Distributor. If you need assistance locating your local distributor, please contact Lexicon at 888-691-4171.

This manual does not include all of the details of design, production, or variations of the equipment. Nor does it cover every possible situation which may arise during installation, operation or maintenance.

The information provided in this manual was deemed accurate as of the publication date. However, updates to this information may have occurred. To obtain the latest version of this manual, please visit the Lexicon website at www.lexicon.com.

Trademark Notice:

Lexicon and the Lexicon logo are registered trademarks of Harman International Industries, Inc.

Later versions of this manual and additional information about this product may be available at the Lexicon website at www.lexicon.com.

©2017 by Harman International,
8500 Balboa Blvd, Northridge, CA 91329 U.S.A. Telephone: 888-691-4171.

DOCUMENTATION CONVENTIONS

This document contains general safety, installation, and operating instructions for the DD-8 Power Amplifier. It is important to read this user guide before attempting to use this product. Pay particular attention to safety instructions.

The following symbols are used in this document:



Appears on the component to indicate the presence of uninsulated, dangerous voltage inside the enclosure – voltage that may be sufficient to constitute a risk of shock.



Appears on the component to indicate important operating and maintenance instructions in the accompanying literature.

CAUTION

Calls attention to a procedure, practice, condition or the like that, if not correctly performed or adhered to, could result in injury or death.

WARNING

Calls attention to a procedure, practice, condition or the like that, if not correctly performed or adhered to, could result in damage to or destruction of part or all of the product.

NOTE:

Calls attention to information that is essential to highlight.

FCC COMPLIANCE NOTICE

This device complies with part 15 of the FCC rules. Operation is subject to the following two conditions: (1) This device may not cause harmful interference, and (2) this device must accept any interference received, including interference that may cause undesired operation.

CAUTION: Changes or modifications not expressly approved by the party responsible for compliance could void the user's authority to operate the equipment.

NOTE: This equipment has been tested and found to comply with the limits for a Class B digital device, pursuant to part 15 of the FCC Rules. These limits are designed to provide reasonable protection against harmful interference in a residential installation. This equipment generates, uses, and can radiate radio frequency energy and, if not installed and used in accordance with the instruction manual, may cause harmful interference to radio communications. However, there is no guarantee that interference will not occur in a particular installation. If this equipment does cause harmful interference to radio or television reception, which can be determined by turning the equipment off and on, the user is encouraged to try to correct the interference by one or more of the following measures:

- Reorient or relocate the receiving antenna.
- Increase the separation between the equipment and receiver.
- Connect the equipment into an outlet on a circuit different from that to which the receiver is connected.
- Consult the dealer or an experienced radio/TV technician for help.

This device complies with part 15 of the FCC Rules. Operation is subject to the following two conditions: (1) This device may not cause harmful interference, and (2) this device must accept any interference received, including interference that may cause undesired operation.

CAN ICES-3 (B) / NMB-3 (B).

GETTING STARTED

Thank you for purchasing your new Lexicon DD-8+ Network Amplifier. The Lexicon® DD-8+ is an advanced multi-channel amplifier with network controlled matrix routing and multi-channel digital signal processing (DSP); that provides a pallet sound shaping controls and system configuration tools. The DD-8+ features patented DriveCore™ technology, delivering unprecedented levels of power from an amazingly small and lightweight product. DriveCore takes more than 500 discrete components typically found in a switching amplifier and fuses them onto a single silicon chip about the size of a dime. Coupled with a power supply, this chip is capable of generating big output levels into a wide variety of speaker loads giving you the flexibility to power almost any speaker from small in-ceilings to large in-room floorstanding models.

In order to receive the maximum peak performance from your Lexicon amplifier, please take a few minutes and completely read this manual. This important information will help you make certain that your DD-8+ is properly configured for operation with the rest of the equipment in your system. Be sure to check Lexicon.com periodically for the latest DD8+ updates.

Hardware Highlights

- Multi-patented DriveCore™ amplifier technology
- 8-channels each with 125W into 8-ohms, all channels driven
- Four stereo, eight mono, or any combination stereo/mono channel configuration
- Local and Bus RCA inputs for single or multi-zone flexibility
- DC trigger input/output and signal sensing for power control
- Front panel illuminated standby button
- Front panel channel status indicator LED's
- Short-circuit and thermal protection circuitry
- High-efficiency, quiet convection-cooled design
- Lightweight chassis only one rack space (1U) high
- Low-power consumption standby modes (less than 0.5W)

Configuration Dashboard Highlights

- Built-in Digital Signal Processor (DSP) accessible via Network-connected computer
- Matrix switcher – assigns any and all input sources to any or all outputs
- Optional renaming of every input and output channel
- Independent channel output level controls
- Check and update firmware from the dashboard
- Compatible with IP control/automation systems by Crestron, AMX, Control 4 and Savant
- Ten-band parametric equalizer with pink noise generator
- Bass and treble control per channel
- Output limiter per output channel
- Output time delay control
- Variable High-pass and Low-pass filters per channel

GETTING STARTED

Installation Considerations

To ensure optimal performance, pay particular attention to the instructions below and to other precautions that appear throughout this user guide.

DO install the DD-8+ on a solid, flat, level surface such as a table or shelf. The DD-8+ can also be installed in a standard 19-inch equipment rack using the rack-mount ears included with the product.

DO select a dry, well-ventilated location out of direct sunlight.

DO NOT install the DD-8+ on a surface that is unstable or unable to support all four feet.

DO NOT expose the DD-8+ to high temperatures, humidity, steam, smoke, dampness or excessive dust. Avoid installing the amplifier near radiators and other heat-producing appliances.

DO NOT install the DD-8+ near unshielded TV or FM antennas, cable TV decoders, or other RF-emitting devices that might cause interference.

DO NOT place the DD-8+ on a thick rug or carpet, or cover the ventilation holes in the chassis, as this might prevent proper cooling.

DO NOT place the DD-8+ on a windowsill or any location exposed to direct sunlight.

Installation Options

The DD-8+ is shipped without feet or rack ears installed. Both are included in the packaging and you will need to install one or the other depending upon the type of installation/mounting required. If the DD-8+ is to be placed on a shelf or audio furniture, you will need to attach the four plastic feet to the bottom of the amplifier using a #2 Philips screwdriver and the included hardware. (See Figure 1) If the DD-8+ is to be mounted into an equipment rack, you will need to attach the two metal rack ears to the left and right sides of the amplifier using the included T-10 Torx key. (See Figure 2)

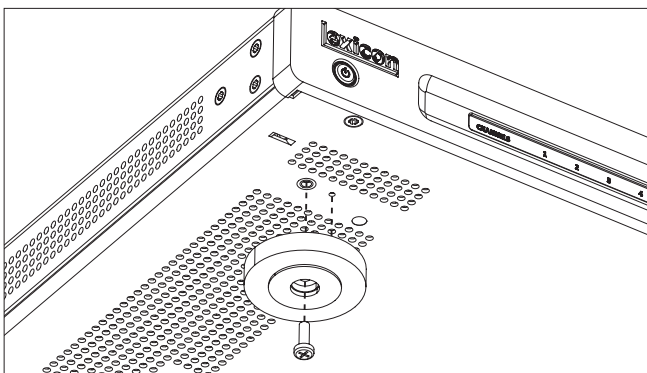

Figure 1. Feet Installation

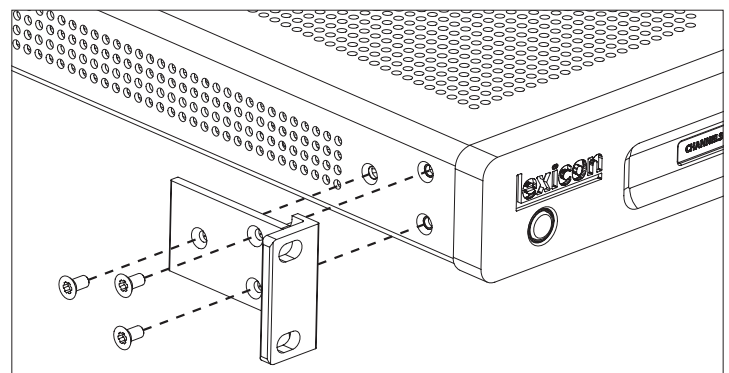

Figure 2. Rack Ears Installation

NOTE: If multiple DD-8+'s are to be rack mounted together, it is acceptable to "flat stack" them one atop the other in adjacent rack spaces without additional ventilation spaces left in between them. However, in some installations or in heavy usage scenarios where multiple channels are consistently driven at high outputs for long periods of time, it might be necessary to leave one empty rack space between the amplifiers in order to assist with heat dissipation and prevent thermal protection due to overheating.

BASIC OPERATION

Front Panel



Figure 3.

1. Standby Button
2. Channel Status Indicator LED's

1. Standby Button

Activates and deactivates standby mode when the DD-8+ amplifier is connected to AC power.

When the DD-8+ is connected to AC power, the standby button LED will glow RED indicating that the unit is in the *standby* mode. In this state, the power amplifier section is not activated and the unit consumes minimal AC power. Pressing the standby button from this state will activate the power amplifier section and the standby button LED will glow BLUE indicating that the DD-8+ is powered on.

NOTE: When the status of the DD-8+ changes or is powered up from standby mode, there may be a delay in audio output and relay clicks may be audible. This is normal operation.

NOTE: If the trigger input is used on the DD-8+, it will override the standby button operation.

2. Channel Status Indicator LED's

Indicates the status of each of the eight amplifier channels when the DD-8+ is active.

When a channel is active, its LED indicator will glow BLUE. If the channel is in standby, the LED will be off. If a channel has a fault, the LED will blink BLUE indicating the presence of a short or some other problem related to that channel. (See the *Troubleshooting* section for more information.)

BASIC OPERATION

Back Panel

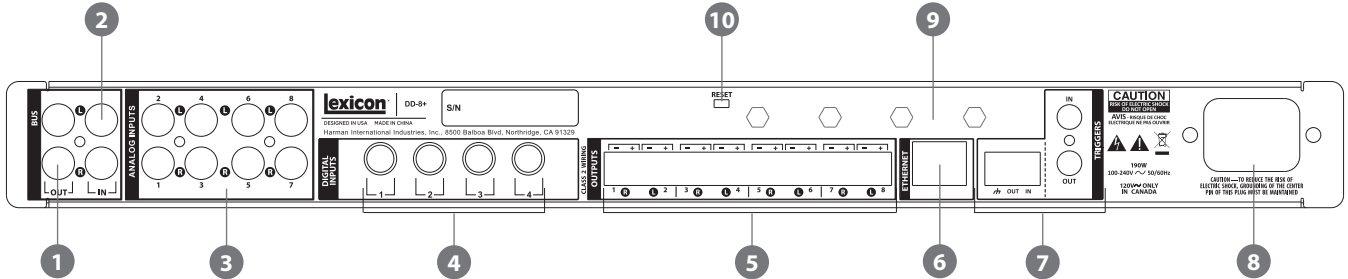

Figure 4.

- | | |
|--------------------------|----------------------------|
| 1. Bus Output | 6. Ethernet Port |
| 2. Bus Input | 7. Trigger In/Out |
| 3. Analog Inputs | 8. AC Main Power Connector |
| 4. S/PDIF Digital Inputs | 9. MAC ID Label |
| 5. Speaker Outputs | 10. Reset |



CAUTION: Never make or break connections to the DD-8+ unless the DD-8+ and all associated components are powered off



WARNING: Do not connect the outputs of one channel to the outputs of other channels or to other amplifiers.

BASIC OPERATION

The DD8+ is a network amplifier and must be connected to a network router via the Ethernet jack on the back of the unit. Most of the controls normally found on the front and rear panels of an amplifier can be found in the Configuration Dashboard that is accessed via a PC/Mac connected via web browser. See *Configuration Dashboard* instructions.

Connection Terminals

1. Bus Output

Provides a line-level RCA connector loop/pass through output for connecting multiple DD-8+ amplifiers in a system utilizing a single stereo bus input signal.

If the DD-8+ is used as a single zone amplifier and the input signal is connected via the Bus Input, that signal can be output via this pair of RCA connectors to additional DD-8+ amplifiers connected in the same manner.

NOTE: The number of DD-8+ amplifiers that can be connected in this manner is limited by the output voltage of the signal source device driving the bus input as it must support the total impedance of all of the bussed devices.

2. Bus Input

Provides a line-level RCA connector input to simultaneously feed any or all speaker output channels utilizing a single stereo bus input signal. The Matrix Switcher allows any input to be assigned to any single or combination of output channels. See the *Advanced Operation – Matrix Switcher* on page 20 for more information.

3. Analog Inputs

Provides a line-level RCA connector input to feed any or all speaker-level output channels. The Matrix Switcher function allows any analog input to be assigned to any single or combination of output channels. See the *Advanced Operation – Matrix Switcher* section on page 20 for more information. These inputs are numbered 1-8 on the rear panel but may be renamed. See *Configuration Dashboard* instructions beginning on page 14 for more information on relabeling and input assignment.

4. Digital Inputs

These inputs are numbered 1-4 on the rear panel but may be renamed within the Configuration Dashboard. Inputs accept coaxial cable feeds from digital sources that can be assigned to any or all output channels using the Matrix Switcher function in the Configuration Dashboard. See the *Matrix Switcher* section on page 20 for more information.

BASIC OPERATION

5. Speaker Outputs

Provides connection for up to four pair of stereo speakers (eight speakers total) to the DD-8+. Connection is provided via phoenix-type connectors that accept bare wire terminations. The connectors are grouped in pairs with one connector each for output pair 1-2, 3-4, 5-6 and 7-8. Each pair consists of four wire terminations: positive (+) and negative (-) for the Left channel and positive (+) and negative (-) for the Right channel. To attach speaker cables to the phoenix connector, strip approximately ¼" (13mm) of insulation off of the end of the positive and negative leads of the cable and insert the bare ends into the corresponding position of the phoenix connector, tightening the screw terminals on top to secure the termination. Repeat this procedure for each speaker.

NOTE: Use 16-gauge or larger speaker wire in order to ensure low-impedance connections between the amplifier and speakers. Be sure to observe correct polarity when making connections to speakers: Positive (+) leads to the Positive (+) terminals and Negative (-) leads to the Negative (-) terminals.



CAUTION: The speaker outputs on the DD-8+ are balanced (differential) and should not be connected to any equipment that grounds the Negative (-) terminals.

6. Ethernet Port

Provides access to the Configuration Dashboard for system set-up including channel volume trim, input assignment, equalization and other functions. See *Configuration Dashboard* instructions on page 14. After initial set-up it provides connection to IP control/automation systems from Crestron, Control 4, Savant and AMX. See *Third Party IP Control Systems* instructions on page 26.

7. Trigger In/Out

Provides connectivity for remote 5-15VDC trigger signals used to activate and deactivate the standby mode of the DD-8+.

The Trigger In and Out connections can be used to activate and deactivate the standby mode of the DD-8+ from devices such as remote control systems, preamplifiers or other external devices. The Trigger In and Out connections are duplicated for both 1/8" (3.5mm) mono mini-plug and phoenix- style connectors. Use the Trigger In for making connections to external control devices that will activate and deactivate the DD-8+ standby mode. The Trigger Out does not provide DC power on its own, but can be used for making Trigger In daisy-chain connections to additional DD-8+ amplifiers or other components that need to mimic the DD-8+ power state.

NOTE: When a remote trigger is connected it will override the front panel standby button operation.

NOTE: Trigger connections are required if you plan to use the Green Mode feature with a third party IP control system. When Green Mode is engaged, instructions from IP control systems will not restore the amplifier to ON. Only a trigger signal will return the amplifier to ON status.

BASIC OPERATION

To install a trigger cable:

- Power the controlling source and DD-8+ amplifier off.
- Connect the trigger cable to the controlling source and the DD-8+ amplifier.
- After the connections are made, power on the controlling source and the DD-8+ amplifier. After the source unit is fully powered up, the LED power indicator on the front of the DD-8+ should be lit BLUE.
- Verify the trigger is working by putting the source unit into standby mode. The DD-8+ amplifier after a short delay will also go into the standby mode and the power indicator will light up RED.
- Once you have verified that the trigger cable is working, only use the source unit to power on and off your DD-8+ amplifier.



WARNING: When installing the trigger cable, never have the controlling source or DD-8+ amplifier powered on; doing so will cause the trigger device to work improperly and could cause damage to both the source and amplifier.

8. AC Main Power Connector

Provides an AC power connection to the DD-8+ using the supplied power cord.

After all audio and system connections have been made, connect the power cord to an AC power source. Be sure that any device connected to the remote trigger input is powered off when connecting the DD-8+ power cord to an AC outlet.



WARNING: Do not plug the DD-8+ directly into the “Switched Accessory” outlet of another device! These outlets are intended for use with low current draw products such as tuners, CD players, Blu-ray players and other similar devices. These outlets are not designed to handle the high current draw of a power amplifier. Using these outlets for a power amplifier is a significant safety hazard.

9. MAC ID

The MAC ID for the unit is provided on a label located above the Ethernet port on the back on the DD-8+. This identifier is unique to every unit – record and store this ID for network identification.

10. Reset

Resets all functions and controls to factory defaults.

NOTE: The RESET button will erase all custom configurations enacted up to that point in time. Use only as a last resort when all other attempts to correct a fault have failed. See *Troubleshooting and Maintenance* section on page 27.

BASIC OPERATION

Identify DD8+ IP Address for Web Configuration Dashboard Access

Overview

The Lexicon DD8+ features a web-based Configuration Dashboard for system set-up. As long as the DD8+ is connected to the same network as the controlling device (PC, Mac or Mobile device), the Configuration Dashboard can be accessed via an Internet Browser such as Chrome, Safari or Firefox. The web GUI provides a highly convenient means of accessing the internal DSP to configure the DD8+ for maximum usability and performance.

NOTE: The DD8+ is optimized for tablets. The user experience differs slightly depending on the system. Graphic refresh rates vary depending on browser, operating system, speed and connection to the network, as well as the speed of the controlling device. In some circumstances the graphics may take several seconds to redraw.

Hardware Connection

1. Begin by hardwiring the DD8+ RJ45 Ethernet connection to a router.
2. Take note of the MAC ID listed above the Ethernet port. You will later identify the device on the network by this ID number.



Figure 5.

3. Connect your computer or mobile device to the same router (wired or wireless).
4. Make sure the DD8+ is powered on and is not in standby mode (blue light should be illuminated).

NOTE: The DD-8+ will not communicate with the network in standby mode.

There are a few different ways to identify the DD8+ on the network. Several free software applications are available for PC, Mac, and iOS that will scan the network from a. Many installers find this process the simple and fast. This process is outlined below.

NOTE: The DD-8+ will use DHCP to obtain an IP address, therefore, the IP address is assigned by the router and will change each time the unit is connected. The Mac ID will remain the same for the particular unit.

BASIC OPERATION

Identifying the IP Address – Windows 7, 10

1. Download an **IP Scanner** (search “ ip scanner for PC” there are several).
2. Make sure you are on the same network as the DD-8+.
3. Once program is open, click “Scan”
4. The DD8+ can be identified by the MAC address and Manufacturer name. (Harman)
5. Take note of the IP address
6. Type the associated IP address into your web browser (internet explorer not recommended) to access the DD8+ Configuration Dashboard

Identifying the IP Address – iOS Device

1. Search for “**Free Network Analyzer**” or similar search on the App Store. There are several free applications.
2. On your iOS device: go to settings / Wi-Fi and select the same network that the DD-8+ is connected to.
3. Open the application on your iOS device and select the “LAN” Function then press “Scan”.
4. The DD8+ can be identified by the MAC address and the name “Harman Specialty Group”
5. Type the associated IP address into your web browser to access the DD8+ Configuration Dashboard.

Identifying the IP Address – Mac OSX (Lion and newer)

1. Install a Lan Scanner from the App Store.
2. Make sure you are on the same network as the DD-8+
3. Open the application on your mac OS device and select Scan function on LAN.
4. The DD8+ can be identified by the MAC address and the Vendor name “Harman Specialty Group.”

Identifying the IP Address – through the network router

Different brands of routers have different user interfaces and terms. Generic instructions are below. Consult your router manual for more information on navigating the router manufacture’s UI.

1. Log in to your network router page
2. Look for attached devices, this may be in the advanced tab.
3. Look for the device name DD8P – XXXXXX (last 6 characters of MAC ID) this may be under “Wired Devices”
4. Type the associated IP address into your web browser (internet explorer not recommended) to access the DD8+ Configuration Dashboard

NOTE: The DD-8+ will use DHCP to obtain an IP address. If that fails use the factory assigned static IP address of 192.168.50.4 as a fallback. You may need this number in order to access the Configuration Dashboard functions.

BASIC OPERATION

Configuration Dashboard — Set-Up, Inputs And Processor Channels

The Configuration Dashboard is a highly convenient means of accessing the Digital Signal Processor (DSP) to configure the DD-8+ for maximum usability and performance. Several vital features, functions and controls can be found only within the Configuration Dashboard.

The window pictured in Figure 6 will appear.

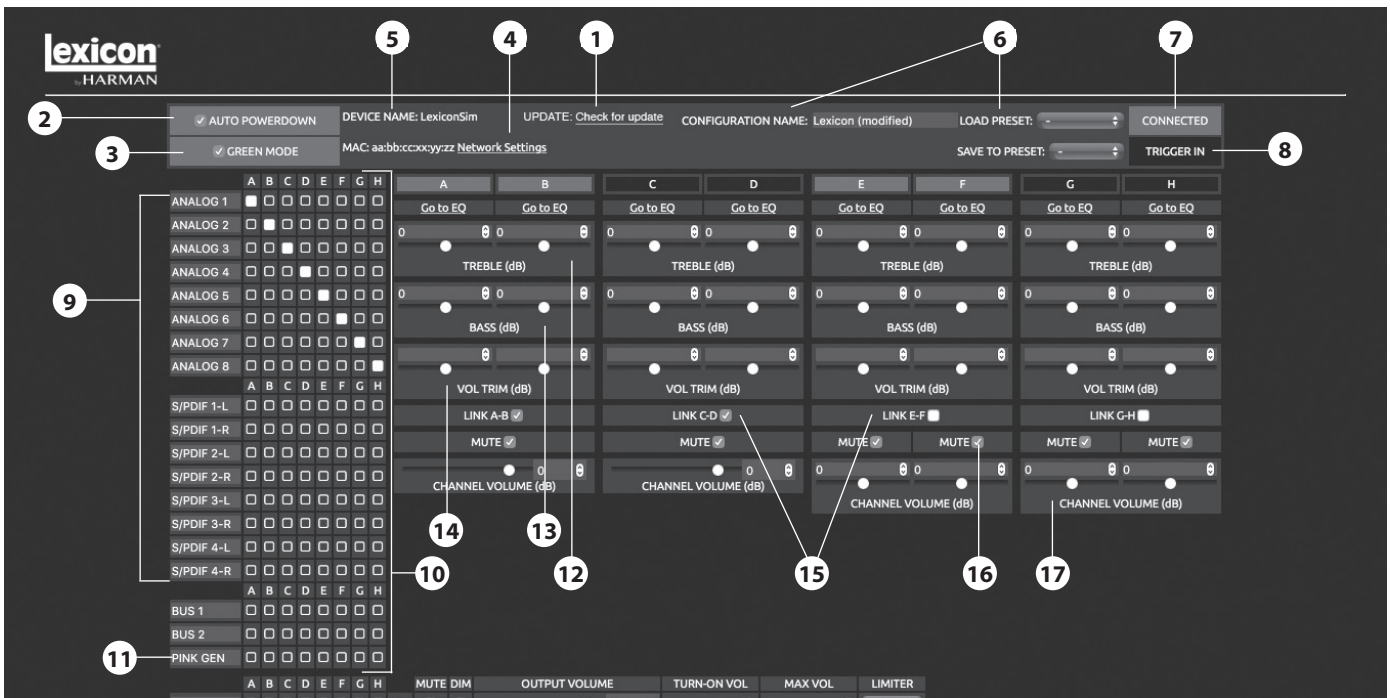

Figure 6. Configuration Dashboard

IMPORTANT! 1. Check for Update

Click this link to check for the latest firmware version. Follow updating firmware instructions.

IMPORTANT! 2. Auto Powerdown

Enables the audio Signal Sense circuitry for all inputs when the checkbox is selected. The default value is ON (Auto Powerdown engaged). To turn this off you must deselect the check box. Save as a preset in order to preserve the state in the event of a power outage.

The Auto Powerdown circuitry allows the DD-8+ to activate any or all channels when an audio signal is detected at its assigned input(s) and deactivate any or all output channels when no audio signal has been detected for 30 minutes. When the DD-8+ is powered on and the Auto Powerdown is engaged, amplifier output channels with signal present will be active. Output channels without signals present at their assigned inputs will remain switched off until signals are detected. In this mode, power consumption is lowered by switching off idle channels. In cases where Auto Powerdown is engaged and no audio signals are present on any channels for more than 30 minutes, all channels will be switched off and only the front panel standby button will glow blue while the DD-8+ continues to monitor all inputs for a signal.

BASIC OPERATION

IMPORTANT! 3. Green Mode

Enables the extreme low-power ½ Watt automatic standby mode of the DD-8+. The default value is ON (Green Mode engaged). To turn this off you must deselect the check box. Save as a preset in order to preserve the state in the event of a power outage.

The DD-8+ is a highly efficient design with lower-than-average power consumption at standby, idle and in normal operation mode. The Green Mode lowers standby power consumption even further to ½ Watt by disabling all circuitry except that required for the front panel standby button. If the Green Mode checkbox is selected (the default state), the DD-8+ will automatically revert to standby and enter this extreme low-power state after one hour without signal present at any of the inputs.

If the both the Green Mode and Auto Powerdown checkboxes are deselected (disengaged), the DD-8+ will remain on indefinitely regardless of the presence of input signals until the amplifier is put into standby mode via external trigger or the front panel standby switch when a trigger is not connected.

NOTE: If the DD-8+ is being used with a 3rd party IP control system, the control system will be able to “wake up” the DD-8+ from Green Mode only with a trigger signal. In the event of a power outage the DD-8+ will be able to “wake up” by pressing the front panel Standby button or by an external trigger. Connecting a trigger is highly recommended when using the DD-8+ in systems with IP controllers.

4. Device Name

Allows use of the connected computer’s keyboard to give the DD-8+ a unique name to help identify it, such as “Third floor zones.” To change the label, access via the Network Settings link on the Configuration Dashboard.

5. Network Settings

Click this link to Rename Device Name, and establish network communication. By default the “Use Static IP” checkbox is unchecked indicating that the DD-8+ will use DHCP to obtain an address. Should DHCP fail click the checkbox to use the static factory-assigned IP address 192.168.50.4.

NOTE: If you are not familiar with Network settings and DHCP protocols, use the static IP address or get help from an IT or other network specialist.

6. Configuration Name, Load Preset And Save To Preset

Allows the installer to set up to three global configuration presets that can be recalled via 3rd party IP control systems. The CONFIGURATION NAME input displays and lets the installer name the current configuration, such as PARTY, LATE NIGHT, etc. and indicates changes made since loading the preset.

Set up the audio parameters for the preset, use the SAVE TO PRESET dropdown menu to save the current configuration over one of the 3. Use the LOAD PRESET dropdown menu to load one of the 3 presets or the default settings, replacing the current configuration.

7. Connected

When green, confirms that the external PC is properly connected to the DD-8+ Configuration Dashboard.

8. Trigger In

Lights green when external on/off trigger voltage is applied to the DD-8+.

BASIC OPERATION

9. Input Labels

Each Input channel may be relabeled simply by typing in the output label field. Best practice is to rename inputs with the name of the source, such as CD Player L&R, Spotify, & etc.

10. Matrix Switcher

The DD-8+ offers a powerful matrix switcher that allows complete control of signal routing configurations. See *Advanced Operation - Matrix Switcher* on page 20 for more information.

11. Pink Gen (Pink Noise Generator)

When selected, activates a pink noise on the selected processing channel and corresponding outputs. When used with a SPL meter or real Time Analyzer, pink noise is helpful in setting volume levels, selecting bass/treble levels and parametric equalization See *Advanced Operation – Matrix Switcher* on page 20 for more information on how to route pink noise to any given output(s).

12. Treble

Adjusts Treble output at 7kHz and above from -12dB to +12dB in 0.5dB increments. 0dB is default. Level changes are effected either by directly typing in the desired value, sliding the indicator icon or using the arrow up/down buttons. Changes made here are illustrated in the interactive frequency response graphs within the Parametric EQ area of the Dashboard.

13. Bass

Adjusts Bass output at 150Hz and below from -12dB to +12dB in 0.5dB increments. 0dB is default. Level changes are effected either by directly typing in the desired value, sliding the indicator icon or using the arrow up/down buttons. Changes made here are illustrated in the interactive frequency response graph in the Parametric EQ area of the Dashboard.

14. Volume trim

Each channel's relative volume may be set from -6dB to +6dB in 0.5dB increments. This feature is handy for correcting for stereo volume imbalance due to asymmetrical speaker/listener placement or environmental factors, or for balancing levels between inputs so that the audible volume does not vary wildly as the user switches from one input to another. Use the Pink Noise feature described on page 22 to help set input trim. Default is 0dB. Level changes are effected either by directly typing in the desired value, sliding the indicator icon or using the arrow up/down buttons.

15. Link A-B, C-D & Etc.

When selected links the two adjacent processor channels together so that MUTE, and CHANNEL VOLUME are linked into a single control for both linked channels. When deselected the two adjacent processor channels' MUTE and CHANNEL VOLUME controls are independent of each other. The default is LINKED (checked).

BASIC OPERATION

16. Mute

When selected, completely mutes any inputs routed through that processor channel. Default is unchecked or OFF (not muted).

17. Channel Volume

Provides speaker-level volume control for each processor channel or stereo pair. Any inputs routed through the processor will be affected by this volume control. Volume level changes are effected either by directly typing in the desired value, or using the arrow up/down buttons. Output levels range from -70dB to +12dB in 0.5dB increments. Default is 0dB.

BASIC OPERATION

Configuration Dashboard — Outputs

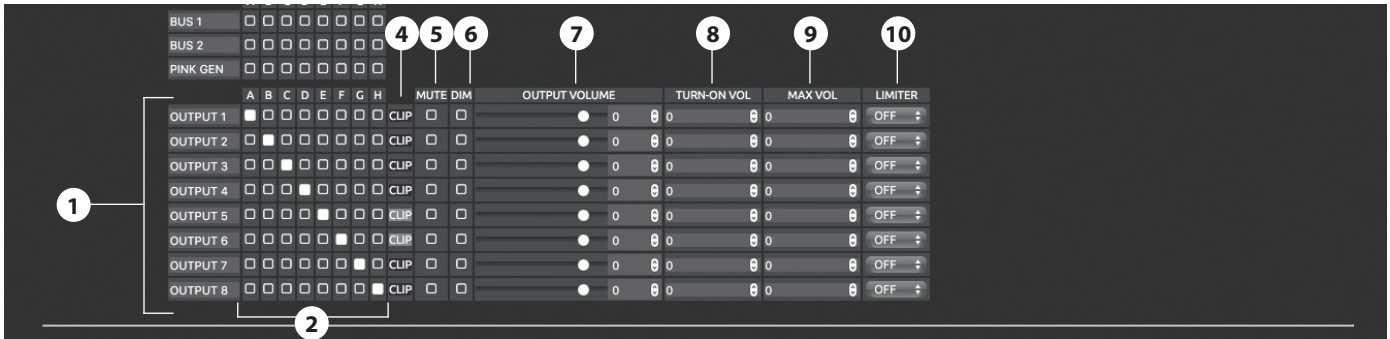

Figure 7. Outputs Dashboard

1. Output Labels

Each output channel may be relabeled simply by typing in the output label field. Best practice is to assign the room or zone names in place of the default output labels of 1 - 8 etc.

2. Matrix Switcher Outputs

Assigns processor channels A – H to specific outputs. See *Advanced Operation - Matrix Switcher* instructions on page 20.

3. SIG Indicator

When lit green, indicates that signal is being routed to the output channel. If any given channel is not green, use the Matrix Switcher to select the desired input and processor channel.

4. Clip

Indicates when an amplifier output is exceeding its undistorted power limit. Use the MAX VOL control to reduce the maximum allowable volume.

5. Mute

Mutes to 0dB the selected output channel. Default is OFF (unchecked).

6. Dim

When selected lowers output volume by -20dB. Default is ON.

NOTE: Because this -20dB mute function is engaged by default, it is the first place to look if you can't get enough gain out of a given channel or pair.

7. Output Volume

Sets the volume level of the loudspeakers connected to outputs 1 – 8.

BASIC OPERATION

8. Turn On Vol

Sets the initial volume upon initial turn-on or restoration from Powerdown mode from -70dB (softest) to +12dB (loudest). Volume level changes are effected either by directly typing in the desired value, sliding the indicator icon or using the arrow up/down buttons.

9. Max Vol

Sets the “hard stop” maximum output volume regardless of the gain selected by external volume controls. It’s a handy feature to prevent damage to loudspeakers and parental eardrums. Volume level changes are affected either by directly typing in the desired value, sliding the indicator icon or using the arrow up/down buttons.

10. Limiter

The limiter tracks the level of the input audio signal and prevents it from exceeding a pre-determined threshold by reducing its gain. Use the dropdown menu to select -3dB, -6dB or -9dB limiter settings. OFF is default.

Check For Firmware Update

IMPORTANT! Once you have accessed the DD8+ dashboard, you should immediately check for firmware updates.

1. Click *Check for Update* Hyperlink.

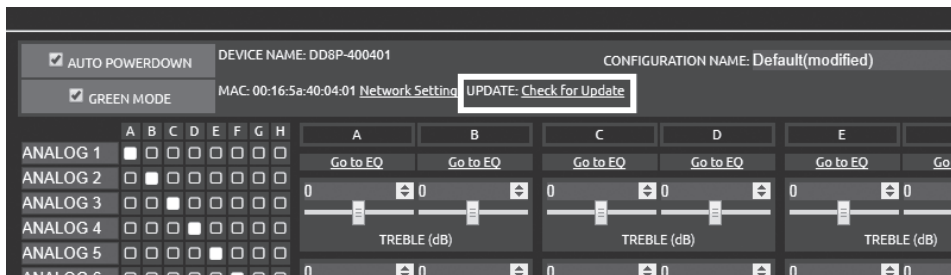

2. If your device is not up to date, you will see your DD8+ version number does not match the Latest Version.

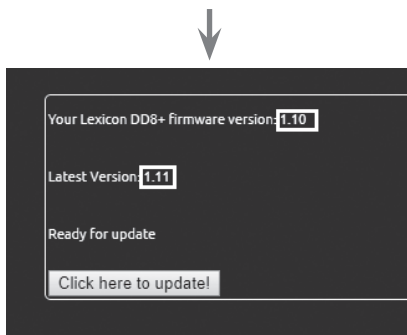

3. Click the Click here to update! Button.



4. Wait for files to load. Do not interrupt this process.

5. Once complete you will see your firmware is up to date.

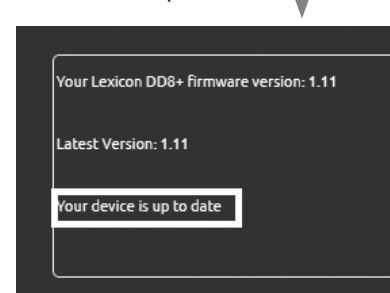

ADVANCED OPERATION

Matrix Switcher

The DD-8+ offers a powerful matrix switcher that allows complete control of signal routing configurations. Any input can be routed through any processor channel and then routed to any individual or multiple output channels.

It is beyond the scope of this manual to describe every possible scenario and signal routing possibility. Figure 8 illustrates the architecture and logic of the mixer.

	A	B	C	D	E	F	G	H
ANALOG 1	<input type="checkbox"/>	<input type="checkbox"/>	<input type="checkbox"/>	<input type="checkbox"/>	<input type="checkbox"/>	<input type="checkbox"/>	<input type="checkbox"/>	<input type="checkbox"/>
ANALOG 2	<input type="checkbox"/>	<input type="checkbox"/>	<input type="checkbox"/>	<input type="checkbox"/>	<input type="checkbox"/>	<input type="checkbox"/>	<input type="checkbox"/>	<input type="checkbox"/>
ANALOG 3	<input type="checkbox"/>	<input type="checkbox"/>	<input type="checkbox"/>	<input type="checkbox"/>	<input type="checkbox"/>	<input type="checkbox"/>	<input type="checkbox"/>	<input type="checkbox"/>
ANALOG 4	<input type="checkbox"/>	<input type="checkbox"/>	<input type="checkbox"/>	<input type="checkbox"/>	<input type="checkbox"/>	<input type="checkbox"/>	<input type="checkbox"/>	<input type="checkbox"/>
ANALOG 5	<input type="checkbox"/>	<input type="checkbox"/>	<input type="checkbox"/>	<input type="checkbox"/>	<input type="checkbox"/>	<input type="checkbox"/>	<input type="checkbox"/>	<input type="checkbox"/>
ANALOG 6	<input type="checkbox"/>	<input type="checkbox"/>	<input type="checkbox"/>	<input type="checkbox"/>	<input type="checkbox"/>	<input type="checkbox"/>	<input type="checkbox"/>	<input type="checkbox"/>
ANALOG 7	<input type="checkbox"/>	<input type="checkbox"/>	<input type="checkbox"/>	<input type="checkbox"/>	<input type="checkbox"/>	<input type="checkbox"/>	<input type="checkbox"/>	<input type="checkbox"/>
ANALOG 8	<input type="checkbox"/>	<input type="checkbox"/>	<input type="checkbox"/>	<input type="checkbox"/>	<input type="checkbox"/>	<input type="checkbox"/>	<input type="checkbox"/>	<input type="checkbox"/>
S/PDIF 1-L	<input type="checkbox"/>	<input type="checkbox"/>	<input type="checkbox"/>	<input type="checkbox"/>	<input type="checkbox"/>	<input type="checkbox"/>	<input type="checkbox"/>	<input type="checkbox"/>
S/PDIF 1-R	<input type="checkbox"/>	<input type="checkbox"/>	<input type="checkbox"/>	<input type="checkbox"/>	<input type="checkbox"/>	<input type="checkbox"/>	<input type="checkbox"/>	<input type="checkbox"/>
S/PDIF 2-L	<input type="checkbox"/>	<input type="checkbox"/>	<input type="checkbox"/>	<input type="checkbox"/>	<input type="checkbox"/>	<input type="checkbox"/>	<input type="checkbox"/>	<input type="checkbox"/>
S/PDIF 2-R	<input type="checkbox"/>	<input type="checkbox"/>	<input type="checkbox"/>	<input type="checkbox"/>	<input type="checkbox"/>	<input type="checkbox"/>	<input type="checkbox"/>	<input type="checkbox"/>
S/PDIF 3-L	<input type="checkbox"/>	<input type="checkbox"/>	<input type="checkbox"/>	<input type="checkbox"/>	<input type="checkbox"/>	<input type="checkbox"/>	<input type="checkbox"/>	<input type="checkbox"/>
S/PDIF 3-R	<input type="checkbox"/>	<input type="checkbox"/>	<input type="checkbox"/>	<input type="checkbox"/>	<input type="checkbox"/>	<input type="checkbox"/>	<input type="checkbox"/>	<input type="checkbox"/>
S/PDIF 4-L	<input type="checkbox"/>	<input type="checkbox"/>	<input type="checkbox"/>	<input type="checkbox"/>	<input type="checkbox"/>	<input type="checkbox"/>	<input type="checkbox"/>	<input type="checkbox"/>
S/PDIF 4-R	<input type="checkbox"/>	<input type="checkbox"/>	<input type="checkbox"/>	<input type="checkbox"/>	<input type="checkbox"/>	<input type="checkbox"/>	<input type="checkbox"/>	<input type="checkbox"/>
BUS 1	<input type="checkbox"/>	<input type="checkbox"/>	<input type="checkbox"/>	<input type="checkbox"/>	<input type="checkbox"/>	<input type="checkbox"/>	<input type="checkbox"/>	<input type="checkbox"/>
BUS 2	<input type="checkbox"/>	<input type="checkbox"/>	<input type="checkbox"/>	<input type="checkbox"/>	<input type="checkbox"/>	<input type="checkbox"/>	<input type="checkbox"/>	<input type="checkbox"/>
PINK GEN	<input type="checkbox"/>	<input type="checkbox"/>	<input type="checkbox"/>	<input type="checkbox"/>	<input type="checkbox"/>	<input type="checkbox"/>	<input type="checkbox"/>	<input type="checkbox"/>

Input Channels

8 Analog, 8 Digital, 2 Bus,
1 Pink Noise

↓ Signal Flow

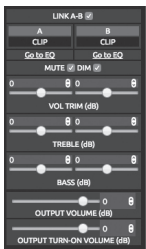

8 Processing Channels

A, B, C, D, E, F, G, H

↓ Signal Flow

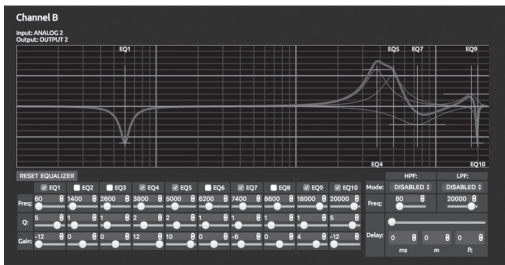

Parametric Equalizer, Filters, & Delay

↓ Signal Flow

	A	B	C	D	E	F	G	H	MAX VOLUME	LIMITER
OUTPUT 1	<input type="checkbox"/>	<input type="checkbox"/>	<input type="checkbox"/>	<input type="checkbox"/>	<input type="checkbox"/>	<input type="checkbox"/>	<input type="checkbox"/>	<input type="checkbox"/>	0	OFF
OUTPUT 2	<input type="checkbox"/>	<input type="checkbox"/>	<input type="checkbox"/>	<input type="checkbox"/>	<input type="checkbox"/>	<input type="checkbox"/>	<input type="checkbox"/>	<input type="checkbox"/>	0	OFF
OUTPUT 3	<input type="checkbox"/>	<input type="checkbox"/>	<input type="checkbox"/>	<input type="checkbox"/>	<input type="checkbox"/>	<input type="checkbox"/>	<input type="checkbox"/>	<input type="checkbox"/>	0	OFF
OUTPUT 4	<input type="checkbox"/>	<input type="checkbox"/>	<input type="checkbox"/>	<input type="checkbox"/>	<input type="checkbox"/>	<input type="checkbox"/>	<input type="checkbox"/>	<input type="checkbox"/>	0	OFF
OUTPUT 5	<input type="checkbox"/>	<input type="checkbox"/>	<input type="checkbox"/>	<input type="checkbox"/>	<input type="checkbox"/>	<input type="checkbox"/>	<input type="checkbox"/>	<input type="checkbox"/>	0	OFF
OUTPUT 6	<input type="checkbox"/>	<input type="checkbox"/>	<input type="checkbox"/>	<input type="checkbox"/>	<input type="checkbox"/>	<input type="checkbox"/>	<input type="checkbox"/>	<input type="checkbox"/>	0	OFF
OUTPUT 7	<input type="checkbox"/>	<input type="checkbox"/>	<input type="checkbox"/>	<input type="checkbox"/>	<input type="checkbox"/>	<input type="checkbox"/>	<input type="checkbox"/>	<input type="checkbox"/>	0	OFF
OUTPUT 8	<input type="checkbox"/>	<input type="checkbox"/>	<input type="checkbox"/>	<input type="checkbox"/>	<input type="checkbox"/>	<input type="checkbox"/>	<input type="checkbox"/>	<input type="checkbox"/>	0	OFF

Speaker Output Channels 1-8

Figure 8. DD-8+ Signal Flow

ADVANCED OPERATION

Figure 9 illustrates an example signal flow from inputs through signal processing channels through speaker outputs. In the illustrated scenario, Analog inputs 1, 2, 3 and 4 are routed through Linked processing channels A and B where Volume Controls, Bass, Treble, Parametric EQ and other audio parameters are applied, and then routed out to speaker OUTPUTS 1, 2, 7 and 8 (renamed with their locations and channel IDs). In this scenario inputs 1 and 3 are Left channel signals, 2 and 4 are right and they are processed separately to maintain their stereo nature.

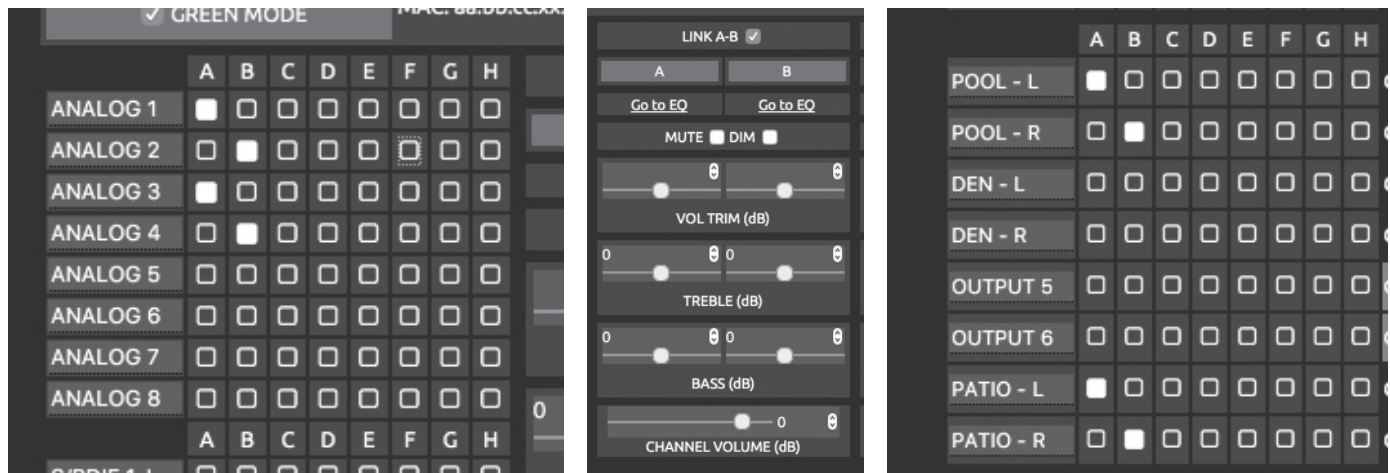

Figure 9.

In the scenario shown in Figure 5, Analog inputs 1 & 2 are summed to mono by selecting the unlinked processor channel “F” and again routed to speaker outputs 1, 2, 7 & 8 (renamed with speaker locations). Inputs 3 & 4 remain in stereo, routed through Linked processor A/B channels and out to speaker outputs 3 & 4 (renamed DEN left and right).

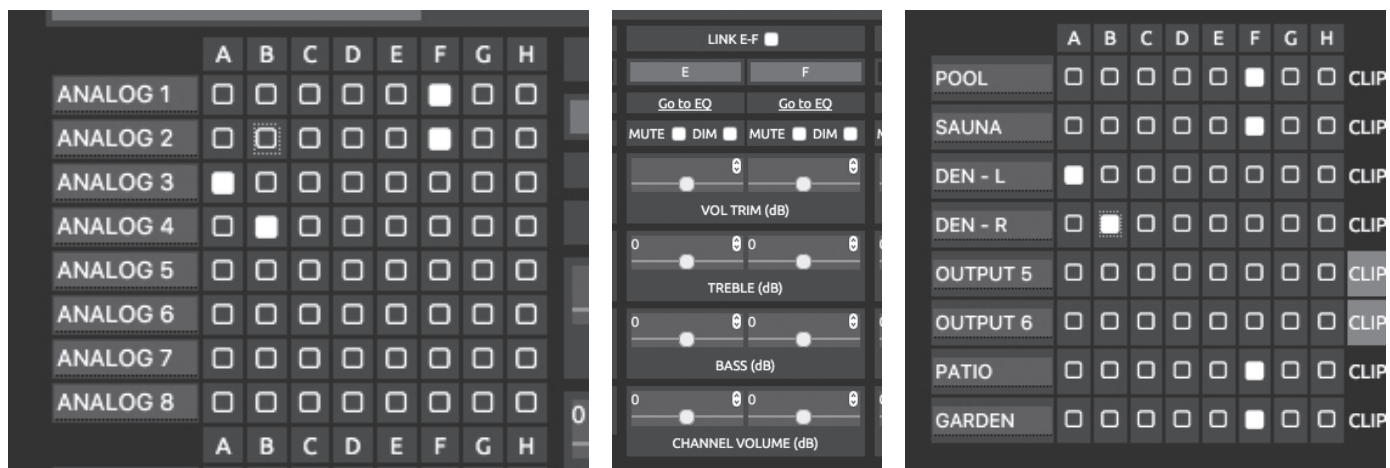

Figure 10.

ADVANCED OPERATION

Pink (Noise) Gen(erator)

Pink noise can be routed to any output channel(s) by using the Matrix Switcher. In Figure 9 the Pink Gen input has been assigned to (turned on) in processor channel D, which is assigned to Outputs 1 and 2, renamed Dining - L and Dining - R. Pink noise is now playing on the speaker pair in the Dining Room, to assist in setting levels or equalization.



Figure 11. Pink Noise routing

Parametric Equalizer

The Lexicon DD-8+ features a 10-band parametric equalizer (PEQ) on each processor channel that can be used to compensate for loudspeaker deficiencies, room acoustics, asymmetrical speaker placement and other factors. Equalization can vastly improve the sound quality of an audio system when skillfully used. Used incorrectly, an EQ can make a system sound bad and may damage the loudspeakers. Use caution when using the PEQ feature particularly if you have little to no experience with their use. Be gentle, especially when boosting gain.

NOTE: If you do not have a Real Time Analyzer and/or do not have experience in setting up equalizers you should not attempt to use the PEQ. Consult a sound engineer, retailer or integrator who has the necessary equipment and experience. Misuse of the PEQ may result in amplifier and/or loudspeaker failure.

The interactive frequency response graphs above each PEQ control panel provide visual feedback of the changes effected by the PEQ, Bass and Treble controls and Output Filters. Use a Real Time Analyzer with the DD-8+'s built in PINK (NOISE) GEN(ERATOR) input to achieve flat measured response and pleasing audible performance. While measurably flat frequency response is a great starting point, user and audible subjective preference should be the final arbiter. Trust your ears.

ADVANCED OPERATION

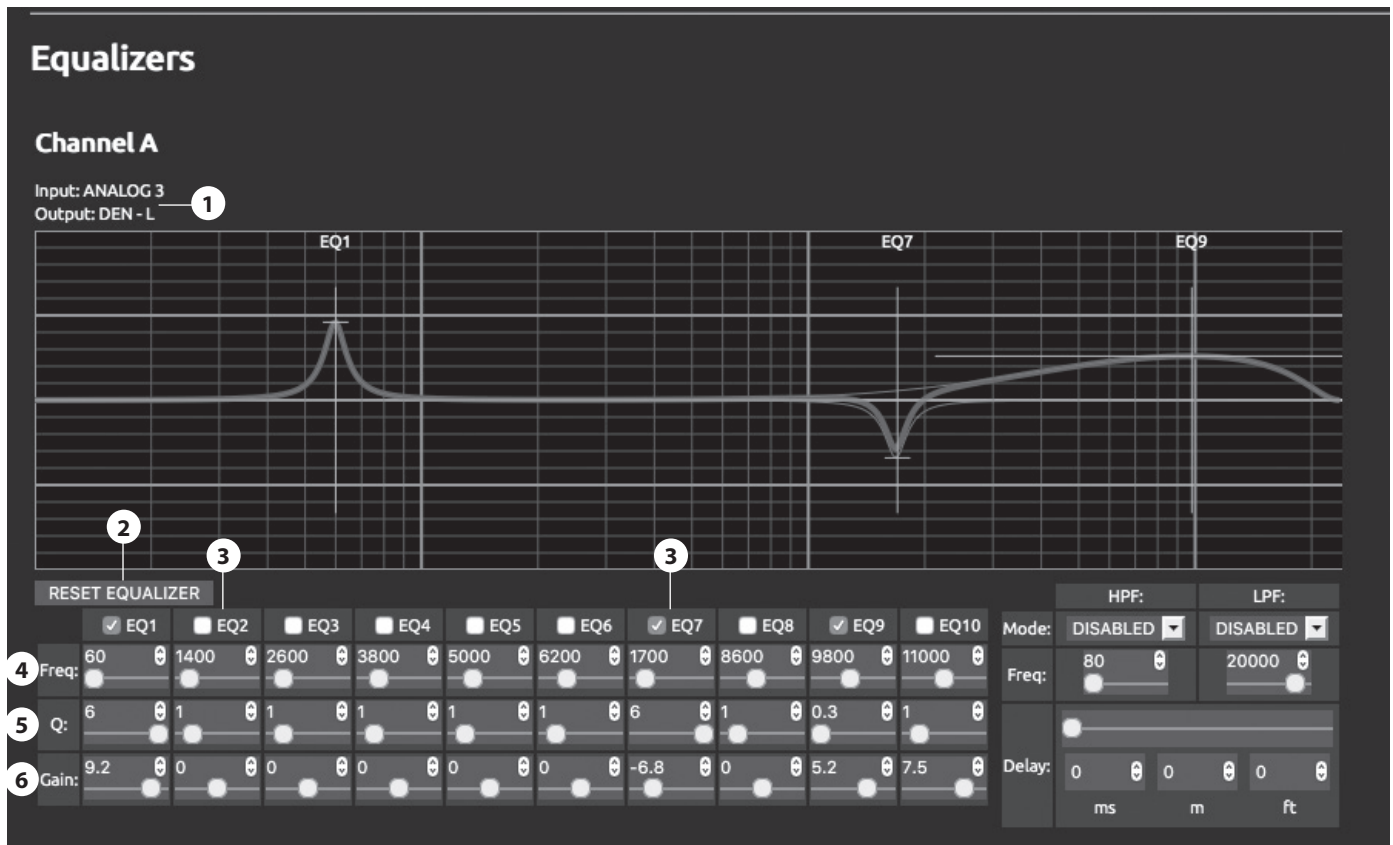

Figure 12.

1. Route Identification

Indicates the input channels that the EQ are acting upon and the output(s) to which the equalized signal is being routed.

2. Reset Equalizer

Turns off all EQ bands and resets all controls to flat. Does not return Bass, Treble controls nor High-Pass and Low-Pass filters to flat.

3. Eq Band On/Off Toggle

Use the check boxes to turn on or off an EQ band. Default value is checkbox OFF. Use the minimum number of frequency bands to achieve the desired result.

4. Frequency

Selects the center frequency of the frequency band to be increased or decreased. Use the slider icon, the up/down arrows to select the desired center frequency or simply type in the frequency in the Freq(uecy) box. Each band can be set at any frequency from 40Hz – 22kHz.

ADVANCED OPERATION

5. Q (Bandwidth)

The “Q” expresses the width of the frequency range being manipulated, usually referred to as the bandwidth. Directly input a value in the text box or use the slider icon or up/down arrows to select Q values from .3 to 6 with increments of 0.1. The default value is 1. A high Q setting means that only a fraction of an octave will be cut or boosted. A low Q setting means that a whole octave or more will be cut or boosted by the EQ. You can see the effects of the Q setting on the interactive frequency response graph above the PEQ control panel. Narrow bandwidths are called for when you believe there is a problem at a very specific frequency such as a cabinet resonance or bass trough or peak caused by room standing waves. Wider bandwidths are more useful for gentle response “smoothing.” Excessively high Q settings can cause other audio artifacts that may sound worse than the original problem. As in all things EQ, be gentle.

6. Gain

Selects the amount of dB the selected frequency range will be cut (up to -12dB) or increased (up to +12dB). Excessive boost of high (over 2kHz) and low (under 200Hz) frequencies may damage loudspeakers. Excessive boost of frequencies under 200Hz will put added strain on the amplifier and limit its ability to play loudly with low distortion. Whenever possible it is better to reduce levels than to boost them in order to achieve the desired tonal balance. Be gentle.



Figure 13. 3kHz center frequency, Q=6, 10dB gain

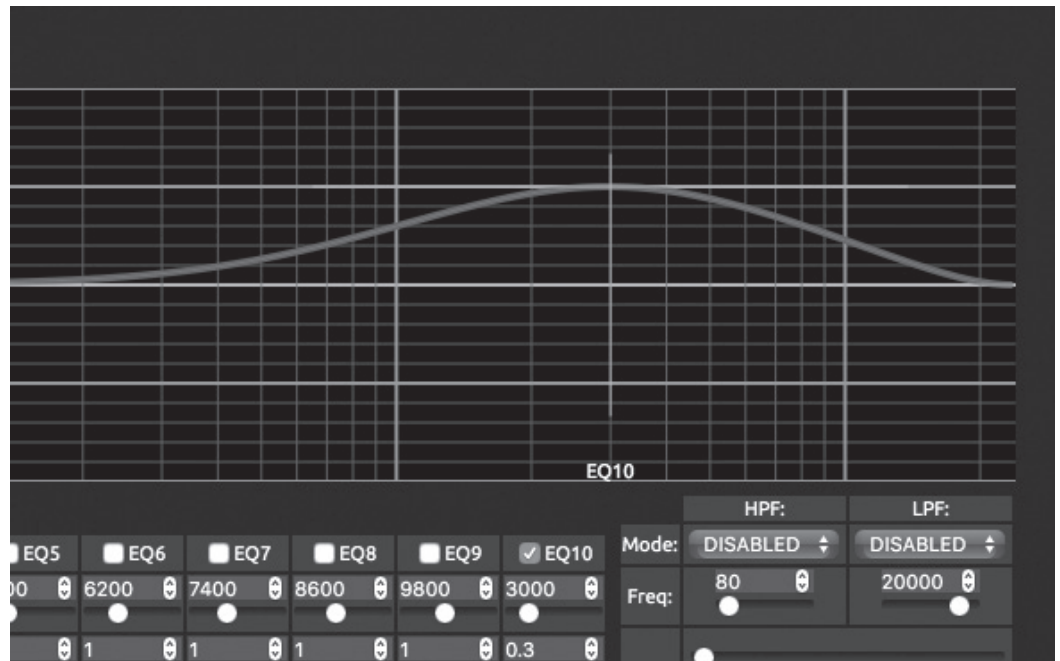

Figure 14. 3kHz center frequency, Q=0.3, 10dB gain

ADVANCED OPERATION

HPF / LPF Output Filters And Delay

Output filters allow you to limit the bandwidth or range over which the amplifier and loudspeakers operate. This is especially useful with small loudspeakers that have limited bass response. Limiting the range of frequencies that the loudspeakers attempt to play may result in better sound quality and greater speaker reliability. Similarly if high frequency response is undesirable in a given location it is easier to simply limit the high frequency output here rather than with the PEQ. The Output Filters may also be used as crossovers when you want to use the DD-8+ to bi/tri-amplify a passive loudspeaker or satellite/(passive) subwoofer system.

“HPF” is the High Pass Filter that passes through high frequencies and filters out low frequencies. “LPF” is the Low Pass Filter that passes through low frequencies and filters out high frequencies.

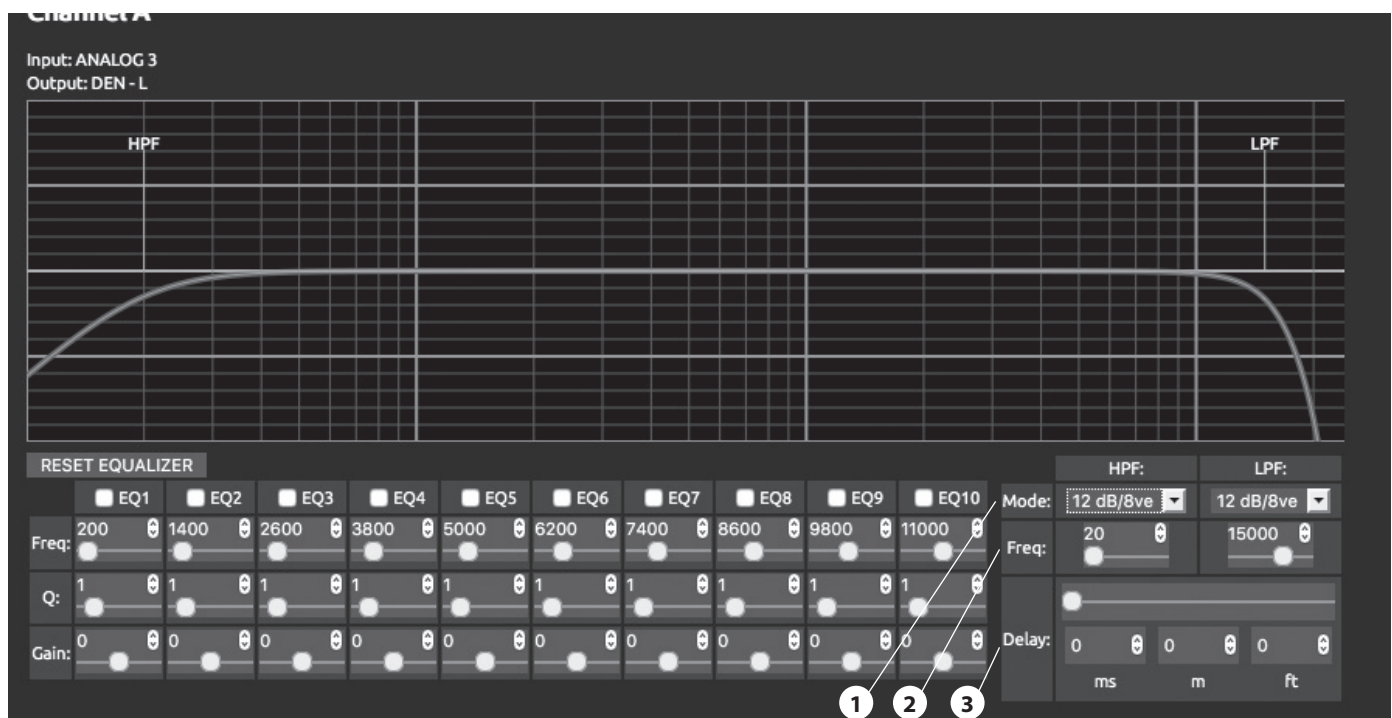

Figure 15. Effects of HPF @ 20Hz and LPF @ 15kHz, 12dB/oct.

1. Mode

Use the MODE dropdown to select between -6dB, -12dB, -18dB and -24dB per octave filter (roll off) slopes. The default value is DISABLED. Steep filter slopes (-18dB, -24dB/octave) may introduce audible artifacts such as “ringing” and may result in poor sound quality. It is best to start with the most gentle roll off filters (-6dB, -12dB/octave) and assess the result before trying more severe roll off settings.

2. Frequency

Type in the numerical value or use the slider icon or up/down arrows to select the frequency where the filter starts to “kick in” (-3dB). Available frequencies range from 100Hz through 22kHz in 100Hz steps.

ADVANCED OPERATION

3. Output Delay

Provides the ability to time delay the output of any stereo pair or individual mono channel by up to 15 milliseconds. This feature can be helpful in achieving more coherent sound with multiple widely spaced speakers such as satellite/subwoofer speaker systems or multiple full range speakers in a very large room. The value can be selected using MS, Feet or Meters. When one value is changed with direct value input, the slider icon or up/down arrows, the other two parameters change accordingly.

For most integrators the easiest method for choosing the correct setting is to input the distance between the farthest speaker to the listening position and the closest speaker. Avoid over-using this feature! In almost all residential installations time delay is not needed at all. When it is, usually just a few milliseconds delay is sufficient to prevent the "echo" or repeating effect of hearing the same sound played through two or more widely spaced speakers.

Third Party IP Control Systems

The DD-8+ may be connected to third party (AMX, Crestron, Control 4, Savant) IP control systems via the Ethernet port.

Software drivers and modules and instructions for specific IP control systems can be found on www.lexicon.com or programed by your custom integrator.

TROUBLESHOOTING AND MAINTENANCE

Troubleshooting

Please visit www.lexicon.com for the latest technical bulletins and documentation.

The amplifier does not power on.

Attempt to power on the amplifier with the front panel Standby/On button.

Examine the power cord to ensure a good connection between the rear panel AC input connector and the wall outlet.

Check the wall outlet.

If connected to a third party IP control system or other external device, connect a trigger cable and send a trigger signal to the DD-8+.

The Trigger Input is connected to an external device, but the amplifier does not power on and off with the external device.

Verify the trigger cable is connected at both ends and verify that the trigger cable is connected to the right device. Also re-verify the trigger installation instructions as instructed in the Basic Operation section of this user guide.

Verify the trigger level of the output source device. The DD-8+ accepts a range of 5-15VDC.

Source signals are present and the system is at a suitable volume level but one or more channels are not passing audio.

1. Open the Configuration Dashboard as instructed in the Basic Operation section of this user guide.
 - a. Confirm that the MUTE and DIM checkboxes are not engaged (checked) on the silent channels.
2. Reduce system volume level, then
 - a. Push the standby mode button on the front panel.
 - b. Check input connections.
 - c. Check speaker connections.
 - d. Allow the amplifier to cool before powering it on again.

TROUBLESHOOTING AND MAINTENANCE

Audio sounds “thin” and is lacking proper bass response.

Check to ensure proper polarity of the speaker cables and connections.

Open the Configuration Dashboard

- a. Check the Bass control setting in the appropriate processing channel. If set to a minus (-) value, raise it by at least 3dB.
- b. Check the Parametric EQ settings to ensure that bass response has not been reduced for that channel or pair.
- c. Disable all PEQ to see if bass response returns to normal
- d. Confirm that the HPF is not enabled on the channel or pair. If it is, reduce the frequency or the attenuation level.

Audio Levels differ between channels.

Check the settings on your preamp, processor or controller.

Audio plays and then cuts off.

Check input and speaker connections for short circuits or loose connections at the amplifier and speaker.

A humming sound is present in the audio.

Audible hum, or a discernable low frequency noise is one of the most common problems within audio/video systems. This problem, even when the volume is at a low level, is usually caused by a common problem known as a “ground loop”. A ground loop occurs when there is a difference in ground voltages between two or more components that are connected electrically.

In most cases, one or more of the following suggestions below will solve the hum problem.

1. If a cable TV connection is present, disconnect the cable for the wall outlet. If this eliminates the humming sound, a ground loop isolation device is required. Contact your dealer or cable provider for assistance.
2. Disconnect components one at a time to isolate the problem. Once the problem is identified, make sure the associated component is properly grounded and connected to the same electrical ground as the DD-8+ amplifier.
3. Turn off all components within your system and then disconnect the input cables on the M-8+ amplifier. Turn the amplifier back on. If the hum disappears the fault may be with the input cables that are being used. Make sure the cables are properly shielded or use a cable that has better shielding. Make sure the cable is not running or laying on top of any AC power cords.
4. Ground loop problems may also be caused by poor grounding of the electrical system within your home or may be caused by faulty earth grounds in your home’s electrical system. To isolate the problem, try unplugging components with three prong grounded power cords one at a time to see if one or all are causing the problem. In the past, cold water pipes and other utilities were often used for grounds. These items may not be still valid because of corrosion of the existing pipes and the installation and use of PVC piping. Please check with a licensed electrician for further evaluation.

TROUBLESHOOTING AND MAINTENANCE

If all else fails...

1. Visit the Lexicon DD-8+ resource web page for update notices, latest manual, and other resources that may help. www.lexicon.com
2. Push the RESET button on the rear panel of the DD-8+
 - a. **NOTE:** The RESET button will erase all custom configurations enacted up to that point in time. Use only as a last resort when all other attempts to correct a fault have failed.
3. Contact an authorized Lexicon dealer.
4. Contact Lexicon Customer Technical Support at 888-691-4171.

Maintenance

Routine maintenance should be performed on a periodic basis. Clean the exterior surfaces of the unit with a soft, dry, lint-free cloth. Do not use alcohol, benzene, acetone-based cleaners, or strong commercial cleaners. Do not use a cloth made with steel wool or metal polish. If the unit is exposed to a dusty environment, a low-pressure blower may be used to remove dust from its exterior.

APPENDIX

Specifications

Output Power:	125W RMS per channel into 8 ohms from 20Hz – 20kHz
Frequency Response:	20Hz - 20kHz +0.2dB/-1.5dB
Total Harmonic Distortion (THD):	<0.02%, 1kHz (at full rated power) <0.1%, 20Hz-20kHz (at full rated power)
Signal-to-Noise Ratio:	< -105dB below rated full power A-weighted
Crosstalk:	< -70dB @ 1kHz
Input Sensitivity:	1.12 volts for 125W out into 8 ohms
Gain:	29dB
Input Impedance (analog):	100K ohms typical
Trigger Input:	5V minimum – 15V maximum DC
Dimensions (H x W x D):	2.1" (w/ feet) / 1.7" (w/out feet) x 17.3" x 14.9" 5.4 cm (w/ feet) / 4.5cm (w/out feet) x 43.8 cm x 37.8 cm
Weight:	9.2 lbs (4.2 kg)
Power Requirements:	100 - 240VAC 50/60Hz

Mode	Power Consumption (W)	Heat Output (BTU/hr)
Standby Mode	<0.5	<2
Idle	<35	<120
Typical	<200	<260
Maximum	1000	680

* Typical usage is considered to be 1/8th power (pink noise) on all channels into the rated load (8 ohms).

LIMITED WARRANTY

Lexicon products are warranted against defects. The duration of a warranty depends on the laws in the country in which it was purchased. Your local Lexicon retailer can help you determine the duration and coverage of your warranty.

For more information please visit: LEXICON.COM

Please visit LEXICON.COM for additional language support on the user manual.

Veuillez visiter LEXICON.COM pour obtenir le mode d'emploi en d'autres langues.

Para obter o manual do usuário em outros idiomas, acesse LEXICON.COM

Ga naar LEXICON.COM voor de handleiding in andere talen.

Gå til LEXICON.COM for bruksanvisning på flere språk.

Если вам требуется дополнительные версии руководства пользователя на других языках, посетите сайт LEXICON.COM.

別の言語に対応したユーザーマニュアルを読むには、LEXICON.COMにアクセスしてください。

사용자 설명서에 대한 추가 언어 지원은 LEXICON.COM에서 확인하십시오

请访问 LEXICON.COM 以获取其他语言版本的用户手册。

Visita LEXICON.COM para obtener el manual de usuario de soporte en idiomas adicionales.

Weitere Sprachfassungen der Bedienungsanleitung findest Du unter LEXICON.COM.

Si prega di visitare LEXICON.COM per i manuali di istruzioni in altre lingue.

Jos tarvitset ylimääräistä kieleen liittyvää tukea käyttöohjeesta, käy osoitteessa LEXICON.COM.

Gå ind på LEXICON.COM for at se betjeningsvejledningen på flere sprog.

Gå till LEXICON.COM för mer information om språk i användarmanualen.

Торговая марка:	Lexicon
Назначение товара:	Пассивная акустическая система
Изготовитель:	Харман Интернешнл Индастриз Инкорпорейтед, США, 06901 Коннектикут, г.Стэмфорд, Атлантик Стрит 400, офис 1500
Страна происхождения:	Китай
Импортер в Россию:	ООО Внешторг-Юг, Россия, 171640, Тверская область, г.Кашин, ул. Карла Маркса, д.57А
Гарантийный период:	1 год
Информация о сервисных центрах:	http://absolut-audio.ru/Service/ тел. +7 (495) 995-10-80
Срок службы:	5 лет
Номер документа соответствия:	Товар не подлежит обязательной сертификации
Дата производства:	Дата изготовления устройства определяется по двум буквенным обозначениям из второй группы символов серийного номера изделия, следующих после разделительного знака «-». Кодировка соответствует порядку букв латинского алфавита, начиная с января 2010 года: 000000-МУ0000000, где «М» - месяц производства (А - январь, В - февраль, С - март и т.д.) и «У» - год производства (А - 2010, В - 2011, С - 2012 и т.д.).

产品中有害物质的名称及含量

部件名称	目标部件	有害物质或元素					
		铅(Pb)	汞(Hg)	镉(Cd)	六价铬(Cr(VI))	多溴联苯(PBB)	多溴二苯醚(PBDE)
电路板	印刷电路板, 电路板上的电子零件 (不包括特定电子零件), 内部相关连接线	X	0	0	0	0	0
箱体	外壳, 面板, 背板等	X	0	0	0	0	0
特定电子零 部件	变压器, 保险丝, 大型电解电容, 电源插座	X	0	0	0	0	0
附件	电线, 说明书, 包装等	X	0	0	0	0	0

本表格依据SJ/T 11364的规定编制

○ : 表示该有害物质在该部件所有均质材料中的含量均在GB/T 26572 规定的限量要求以下。

X : 表示该有害物质至少在该部件的某一均质材料中的含量超出GB/T 26572规定的限量要求。



在中华人民共和国境内销售的电子电气产品上将印有“环保使用期”(EPUP)符号。圆圈中的数字代表产品的正常环保使用年限。



HARMAN International, Incorporated
8500 Balboa Boulevard, Northridge, CA 91329 USA

© 2017 HARMAN International, Incorporated. All rights reserved.

Lexicon and the Lexicon logo are trademarks of HARMAN International Industries, Incorporated, registered in the United States and/or other countries.

Features, specifications and appearance are subject to change without notice.

For questions, assistance or additional information concerning any of our products, call us at: (516) 594-0300 or (888) 691-4171. For technical support, submit your detailed inquiry

 Part No. 070-90057 Rev. 2.0